

Advanced Wind/Solar Hybrid Controller

Model: WWS06A-24

Version 1.0



 **Notes**

1. Thank you very much for purchasing our controller, please read the use manual carefully before installing and using the products and keep it with due care.
2. The installation must be done by experienced technical personnel in the installation operation, the installation process must be strictly in accordance with the use manual to ensure that the product can work properly.
3. This product should be avoided long-term exposure to corrosive gas and moisture environment.
4. Do not put this product in wet, rain, exposure, severe dust, shork, corrosion and strong electromagnetic interference environment.
5. Do not open the shell to repair this product by yourself.

Catalogue

1. General Description.....	1
2. Model Description.....	2
3. Features.....	2
4. Operational Regulations.....	3
5. LCD Operation and Display Instructions.....	4
5.1 Description of the Key.....	4
5.2 Displaying Contents Description.....	5
5.3 Browsing Parameters.....	6
5.4 Manual Brake Setting.....	6
6. Control Software.....	6
7. Parameters.....	9
8. Abnormal Phenomenon and Treatment.....	10

1. General Description

The advanced wind/solar hybrid controller is specially designed for high-end small-scale wind/solar hybrid system and especially suitable for wind/solar hybrid street light system and wind/solar hybrid monitoring system.

The controller adopts PWM to control wind turbine and solar cell charge the battery with voltage limiting and current limiting, namely, the controller will charge battery with current limiting when battery power is low and charge battery with voltage limiting when battery power is high. When the total charge current of wind turbine and solar cell is lower than current limiting point, the controller will charge the battery with the whole power generated by wind turbine and solar cell. When the total charge current of wind turbine and solar cell is more than current limiting point, the controller will charge the battery with the current limiting point, the excess energy will be unloaded by PWM. When battery voltage is lower than voltage limiting point, the controller will charge the battery with the whole power generated by wind turbine and solar cell. When battery voltage is up to voltage limiting point, the controller will charge battery with voltage limiting point and the excess power will be unloaded by PWM. For specifically wind turbine, the controller can achieve accurate speed control, namely, you can set the stop rotation speed. When the wind turbine exceeds this speed, the controller will stop the wind turbine working and the controller will not run the wind turbine until 10 minutes later.

The controller adopts LCD module especially designed for wind/solar hybrid system. The LCD can display battery voltage, wind turbine voltage, photoelectric voltage, wind power, PV power, wind turbine current, PV current, voltage of light control on, voltage of light control off, day or night instructions, battery power status, as well as over voltage, low voltage, short circuit, etc. Users can browse and set the parameters through the LCD key.

The controller is equipped with dedicated remote monitoring software. The software can realize monitoring system status in real-time, such as battery voltage, wind turbine voltage, solar battery voltage, battery charging current, wind turbine charging current, solar charging current, battery charging power, solar charging power, wind turbine charging power, fan speed and so on. The software can configure and modify the system parameters, while the software can control running status of wind turbine.

In addition, the controller has perfect protection functions, including: solar cells reverse charging, solar cells anti-reverse, battery over charge, battery over-discharge, battery anti-reverse, lightning, wind

can be adjusted to suit the fixed feature of the different wind turbine.

- Optional RS232, RS485 interface output
- TVS lightning protection
- Over-charging, over-discharge, short circuit by electronic device, and a unique anti-reverse protection
- Using the LCD professionally designed for wind/solar hybrid street light.The LCD can displays all system status and system parameters with intuitive digital and graph.
- Perfect protection funtion.

4. Operational Regulations

The wind&solar hybrid system connection diagram and the terminal hookup of advanced wind/solar hybrid controller is as follows:

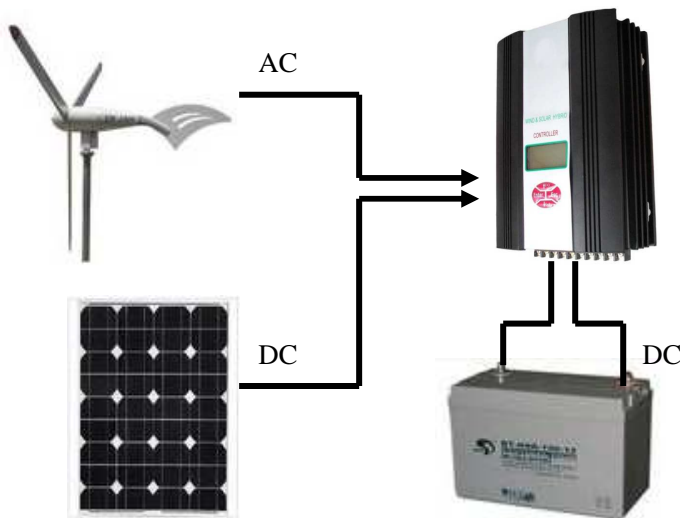

Picture 1, wind&solar hybrid system connection diagram

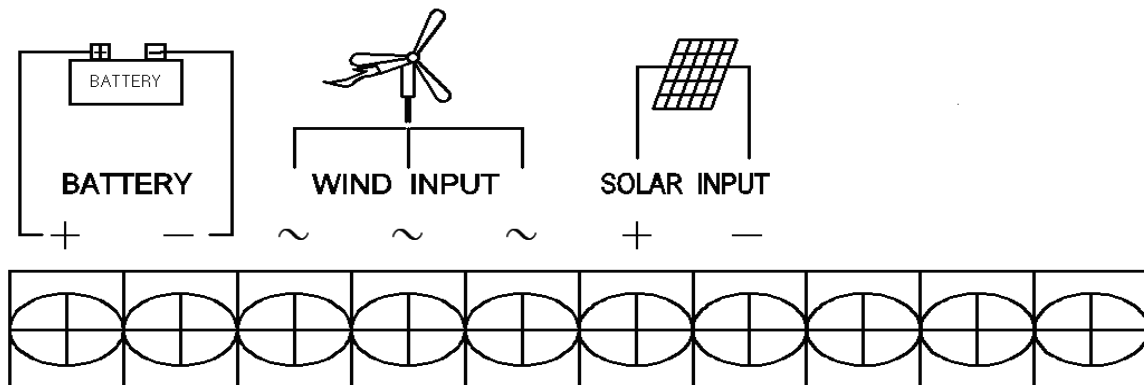

Picture 2, terminal hookup

After the wind/solar hybrid generating system is installed, please connect the controller accurately by the following order .

- Open the package and ensure whether the equipment is damaged due to transportation or not.
- Connect the battery's positive pole to the positive (+) of "BATTERY" terminal, and connect the battery's negative pole to the negative(-) of "BATTERY" terminal with copper core cable(section surface $\geq 6\text{mm}^2$ and length $\leq 1\text{m}$). Despite the controller has the battery reversed protection, but reversing battery is still forbidden!
- Make the wind turbine in brake status and then connect the output line of the wind turbine to the "WIND INPUT" terminal in back panel .
- Cover the solar panel with a shelter and the connect the solar panels to the "SOLAR INPUT" terminal in back panel.
- Remove the shelter of solar panle and release the brake switch of wind turbine.
- Install remote control software, then connect RS232 or 485 interface to computer by data connection.The computer will display the system parameters.
- Users can set the parameters and the mode of load output by the control software and the key of LCD.

5. LCD operation and Display Instructions

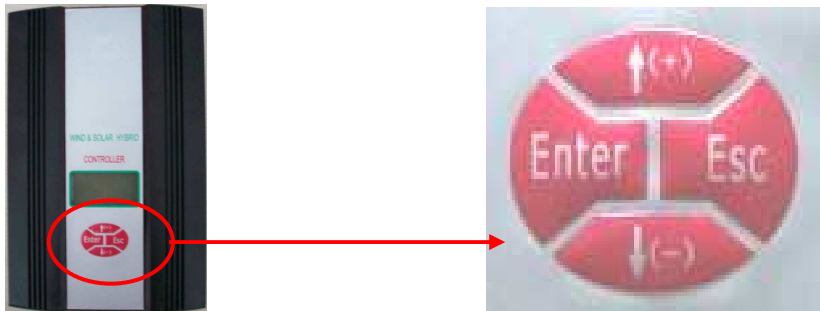

Picture 3, the key of LCD

5.1 Description of the Key:

Press any key, LCD backlight lights. The backlight will auto-off while stop pressing the key 10 seconds later.

- "↑(+)" key symbolizes increase or next one. In browsing window, press this key to display next parameter.In setting window, press this key to look the next parameter which can be modified or









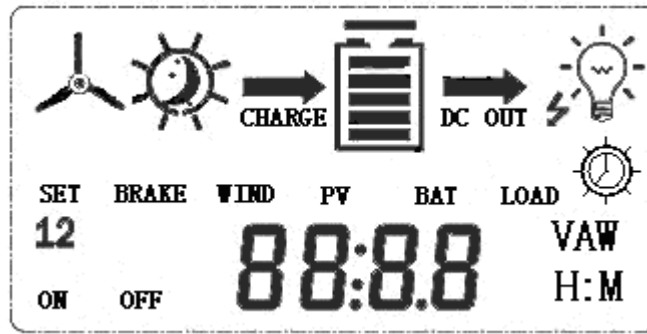

increase the value of the current parameter.

- " ↓ (-)" key symbolizes decrease or previous one. In browsing window, press this key to display the previous parameter. In setting window, press this key to look the previous parameter which can be modified or decrease the value of the current parameter.
- "Enter" key symbolizes set or confirm key. In browsing window, press this key to access setting window. In setting window, press this key to save parameter and return to browsing window.
- "Esc" key symbolizes cancel or manual switch. In setting window, press this key to return to browsing window and do not save the modification. In browsing window, the key is as a manual reset key when the load short-circuit or overload occur.



5.2 Displaying Contents Description

LCD screen displays the following picture.



- 1)  symbolizes the wind turbine.
- 2)  symbolizes the day,  symbolizes the moon.
- 3)  symbolizes the battery, internal strip graph represents the status of battery power. When the battery is over-discharge, the symbol  flashing, this flashing will not stop until over-discharging's recovering ; When the battery is over-voltage, the symbol  flashing ,the flashing will not stop until over-voltage's recovering.
- 4)  symbolizes the status of load.
 - When normal loading without output displays  , normal loading with output displays  .
 - When overloading, the symbol  flashing, users must remove the extra load, click "Esc" key to recover the use of.
 - In short-circuit protection status, the symbol of short-circuit  flashing, users should check the

load line, confirm the line is normal and press Esc key to recovery the use of manually.

- 5)  symbolizes light-control and time-control.  symbolizes light-control open and light-control off.  symbolizes light control open and time control off.
- 6) The character "SET" symbolizes the setting status.
- 7) The character "12" symbolizes the first output and the second output.
- 8) **88:88** is parameters showing. The LCD can displays all system status and system parameters with intuitive digital and graph.

5.3 Browsing Parameters

- 1) Turn the power, the LCD displays browsing window and battery voltage: XX.X V;
- 2) In browsing window, LCD will circularly display the following parameters by pressing " $\uparrow(+)$ " key, battery voltage, wind turbine voltage, photoelectric voltage, wind power, PV power, wind turbine current, PV current, voltage of light control on, voltage of light control off. LCD will display parameters in reverse order by pressing " $\downarrow(-)$ " key.

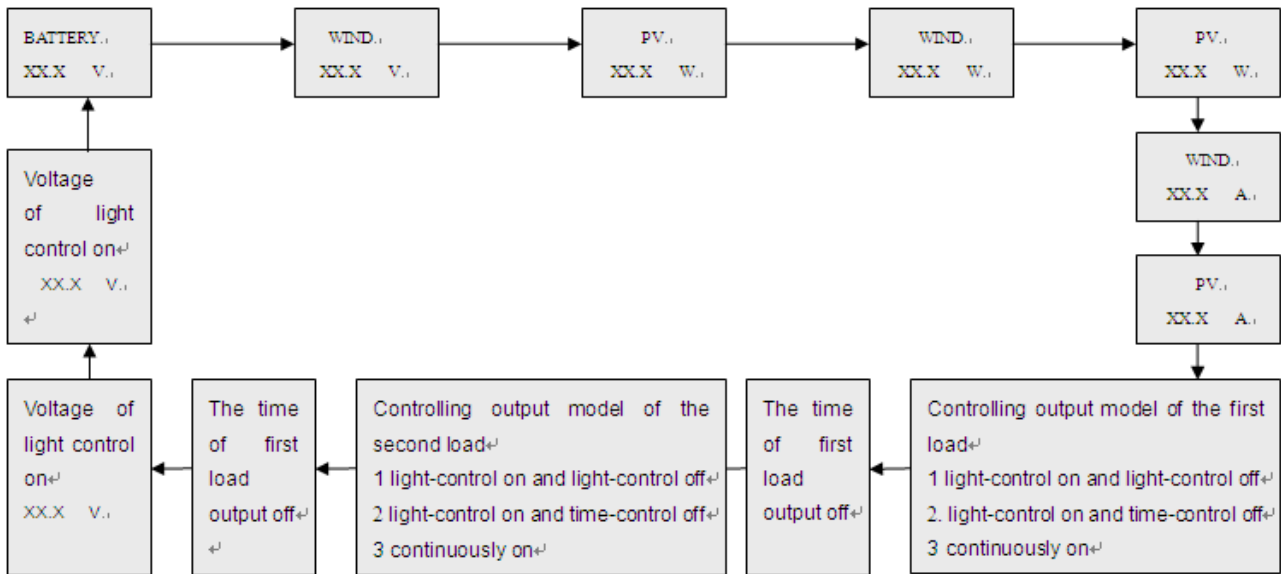

5.4 Manual Brake Setting:

Press the "Enter" key and "Esc" key simultaneously, LCD displays the symbol **BRAKE** that suggests fan is in brake status. Press the "Enter" key and "Esc" key simultaneously in brake status, the symbol **BRAKE** will disappear and the brake status is released. In normal situation, the fan can not be setted in brake status.

6. Control Software

6.1 Software Installation

Double-click "WinController.exe" file → click "Install" → read the agreement of license, click **I**

agree】 if users agree to the terms and conditions → 【Next】 ... → 【Success】 .

(Software installation process is same as general software installation process)

6.2 Use of the software

1. The choice of serial port

By default, the serial port is COM1, the 9-needles serial port back in the general desktop is COM1. Connect the RS232 interface of the controller to COM1 serial port of the computer with serial cable. Connect the controller's power supply, then open the software and complete the connection. After the connection, the light in bottom-right corner of the software is green and the status bar up the light displays "Normal".

If your computer is not COM1 ,you can set it by the following step.

① Firstly, identify your computer's serial port : Right-click "My Computer" → "Properties" → "Hardware" → "Device Manager" → "Ports"; check your serial port.

② Open the software, click "Set" menu→ "serial port", popup the dialog box and select your serial port ;

6.3 The interface of the software instruction

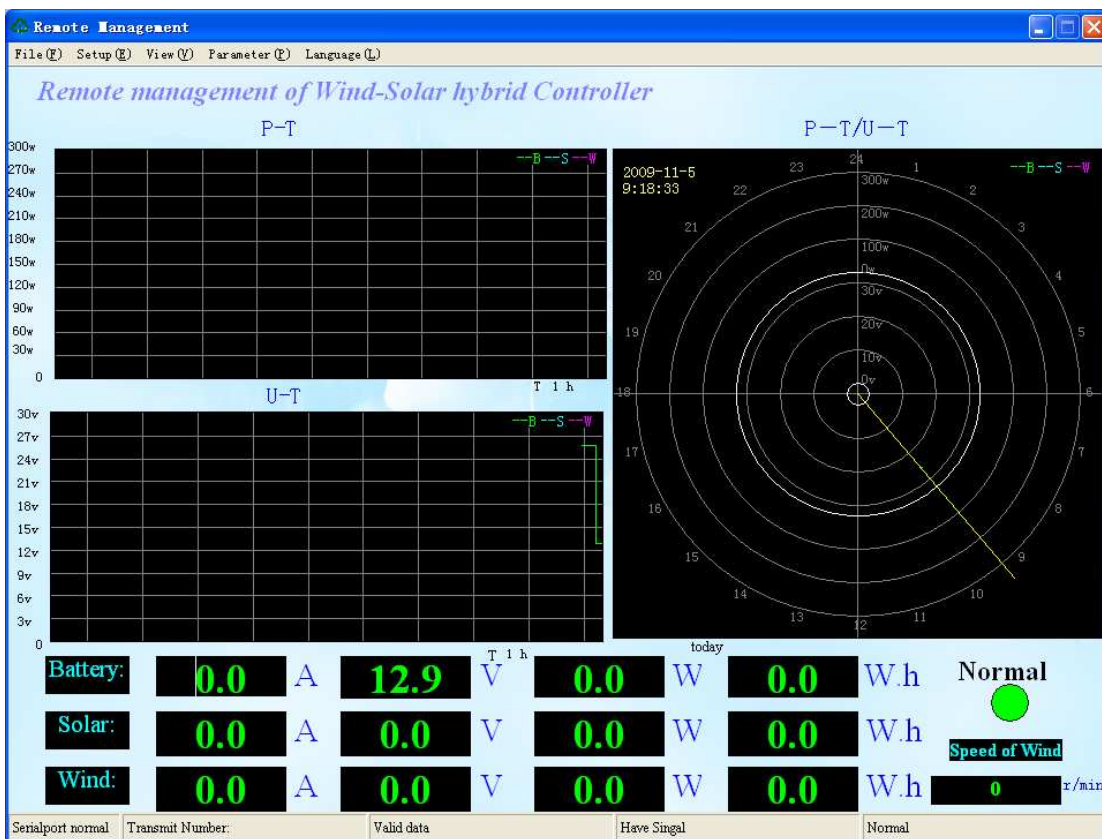

6.3.1 Graphic Displaying Instruction:

● Chant P-T shows the relationship between power and time , the horizontal axis represents time T, the vertical axis represents power W.

- Chart U-T shows the relationship between voltage and time , the horizontal axis represents time T, the vertical axis, said power U.

- Chart P-T / U-T is a polar chart of power -time and voltage-time. The chart shows the date and the time at the same time.

6.3.2 Parameters Displaying Instruction:

- The first column displays battery's parameters , followed by current, voltage, power, quantity of electricity .

- The second column displays solar energy's parameters , followed by current, voltage, power, quantity of electricity.

- The third column displays the wind turbine's parameters , followed by current, voltage, power, quantity of electricity.

- The bottom- right corner shows the light and the speed of fan. The light shows yellow and character "No Signal" when there is no signal, green and character "Normal" when there is signal, red and character "Unload" when controller is unloading, red and character "Low Battery" when battery is low voltage.

The interface displays the speed of fan when the system works well .

6.3.3 Menu Bar Instruction:

- "File" menu

(1) "File" → "The month consumption" (to see the electricity of the month)

(2) "File" → " Inquire electricity" (to see the previous electricity)

(3) "File" → "Save electricity" (to save the electricity of the month)

(4) "File" → "Delete the electricity of the month "

- "Set" menu

"set" menu→"Serial port" menu, select the port

"set" menu→"scale" menu, set the scale of P-T curve and U-T curve

"set" menu→"speed of fan"menu, select "fan speed showing" or "no fan speed showing"

"set" menu→"system selection", select 12V system or 24V system in "controller system" bar and select Chinese-English or English LCD display interface in "LCD interface".

- "View" menu

Users can select which curve will be displayed in the pull-down menu of "View" menu. There are battery curve, solar curve, wind energy curve or all three showing at the same time .

- "Parameter" menu

(1) "Parameter" menu → "Set" menu, users can set or modify the unload voltage point, unload current point, low battery point, low battery recover point, output over-voltage point, PV voltage point of light control on, PV Voltage point of Light control off, RMP of fan stop, input impedance range and wind turbine charge voltage point. Password is needed when modify the parameters and factory



default is 123456.

- (2) "Parameter" menu → "Control" menu, it can controll street light and the wind turbine. Seven controlling modes of street light output are selective, including: (1)constant on, (2)constant close, (3)constant half-power, (4)light-controll on and light-control off, (5)light control on and time control off, (6)light-control on, time-control half-power and light-control off, (7)light-control on, time-control half-power and time control off.

7. Parameters

Model	WWS06A-24
Rated Battery Voltage	24V
Rated Wind Turbine Voltage	28VDC
Rated Wind Turbine Maximum Power	600W
Input Impedance Range	2~30Ω adjustable (3 Ω)
Rated Wind Turbine Maximum Input Current;	40A
Rated Wind Turbine Maximum Input Power	1000W
Wind Turbine Charge Voltage(factory default)	Continuous Adjustable (4V)
Unload Voltage (factory default)	26v~30V adjustable (28V)
Unload Current (factory default)	0~20A adjustable (18A)
Wind Turbine over Speed(factory default)	0~600rpm adjustable, recover automatically 10 minutes later (500rpm)
Rated PV Maximum Power	300W
Rated PV Rated Voltage	34V
PV maximum Current	10A
Battery over-discharge protection Voltage	20v~24V adjustable (22V)
Battery Over-discharge Recovery Voltage	22v~26V adjustable (24V)
Temperature Compensation	-5mv/°C/2V (Over-Discharge Protection, over-discharge recovery voltage unload voltage compensation)
Display Mode	LCD
Display Parameters	Battery Voltage, Wind Turbine Voltage, PV Voltage, Wind Turbine Current, PV Current, Wind Turbine Power, PV Power.Ove-Voltage, Under-Voltage, Over-load, short circuit.Etc
Communication Interface Module	RS—232C (RS485 is selection)
Range of working Temperature &Humidity	-20~+55°C/35~85%RH (Without Condensation)
Quiescent Current	15mA(100mA if the interface is RS485)

8.Abnormal phenomenon and treatment

Phenomenon	Description
The symbol  flashing, without charge or discharge	Battery is over-voltage, check battery voltage, and the cable is connected or not, reconnect all components;
The symbol  flashing and no output	Battery is over-discharging and battery is empty. Please continue to use the battery after charging the battery. Remove the battery and recover it with battery-charging device if the battery is over discharging for a long time.

If the phenomenon do not meet the description or can not return to normal, please contact our service department or salesman to repair or replace.