

User's Manual

Advanced Wind/Solar Hybrid Controller

Model WWS10A-48
Version 1.0



www.neoenerji.com





Notes

1. Thank you very much for purchasing Wind/Solar Hybrid Controller made by Neoenerji Corp.

Please read the instructions carefully before installation and usage and keep it properly.

2. The installation operation must be done by experienced technical personnel and be strictly in accordance with the using manual to ensure the product can work properly.

3. This product should be avoided long-term exposure to corrosive gas and moisture environment.

4. Do not put this product in wet, rain, exposure, severe dust, shock, corrosion and strong electromagnetic interference environment.

5. Do not open the shell to repair this product by yourself.



CONTENTS

1. General Description.....	1
2. Model Description.....	2
3. Features.....	3
4. Operational Regulations.....	3
5. LCD Operation and Display Instructions.....	4
5.1 Description of the Key.....	4
5.2 Displaying Contents Description.....	5
5.3 Browsing Parameters and Output Modes Description.....	5
5.4 Manual Brake Setting.....	6
6. Control Software.....	6
7. Parameters.....	8
8. Abnormal Phenomenon and Treatment.....	10



1. General Description

The advanced wind/solar hybrid controller is specially designed for high-end small-scale wind/solar hybrid system and especially suitable for wind/solar hybrid power generation system system and wind/solar hybrid monitoring system. It can simultaneously control the wind turbines and solar batteries on the battery for safe and efficient charging.

The controller adopts PWM to control wind turbine and solar cell charge the battery with voltage limiting and current limiting, namely, the controller will charge battery with current limiting when battery power is low and charge battery with voltage limiting when battery power is high. When the total charge current of wind turbine and solar cell is lower than current limiting point, the controller will charge the battery with the whole power generated by wind turbine and solar cell. When the total charge current of wind turbine and solar cell is more than current limiting point, the controller will charge the battery with the current limiting point, the excess energy will be unloaded by PWM. When battery voltage is lower than voltage limiting point, the controller will charge the battery with the whole power generated by wind turbine and solar cell. When battery voltage is up to voltage limiting point, the controller will charge battery with voltage limiting point and the excess power will be unloaded by PWM. For specify wind turbine, the controller can achieve accurate speed control, namely, you can set the stop rotation speed. When the wind turbine exceeds this speed, the controller will stop the wind turbine working and the controller will not run the wind turbine until 10 minutes later. The controller adopts LCD module especially designed for wind/solar hybrid system. The LCD can display battery voltage, wind turbine voltage, photoelectric voltage, wind power, PV power, wind turbine current, PV current and battery power status. Users can browse the parameters through the four keys of LCD

The controller is equipped with dedicated remote monitoring software. The software can monitor system status in real-time, such as battery voltage, wind turbine voltage, solar battery voltage, battery charging current, wind turbine charging current, solar charging current, battery charging power, solar charging power, wind turbine charging power, fan speed and so on. The software can configure and modify the system parameters, while the software can control running status of wind turbine and load.

In addition, the controller has perfect protection functions, including: solar cells reverse charging, solar cells anti-reverse, battery over charge, battery anti-reverse, lightning protecting, wind turbine current limiting, wind turbine automatic brake and manual brake.

The low-voltage charging module is optional. The module will enable wind turbine to charge the battery under low-speed. Because the wind turbine has low energy at low speed, so the charging current should not be too large when the fan speed is slow. The low-voltage charging module enables the wind turbine to charge the battery with constant input impedance under low-voltage charging status, namely, the charging current is proportional to charging voltage. Depending on the different characteristics of wind turbines, the input impedance can be modified through serial communication. In addition, users can set wind turbine start charge voltage point through serial communication. Only when the wind turbine voltage is greater than the wind turbine start charging voltage, the wind turbine will charge the battery. The wind turbine start charging voltage can be modified through the serial communication.

The controller has intelligent and modularized design, simple structure, powerful function. The controller use high quality industrial components and excellent production activity, which make the controller is suitable for relatively poor working environment and has reliable performance and service life.

2. Model Description

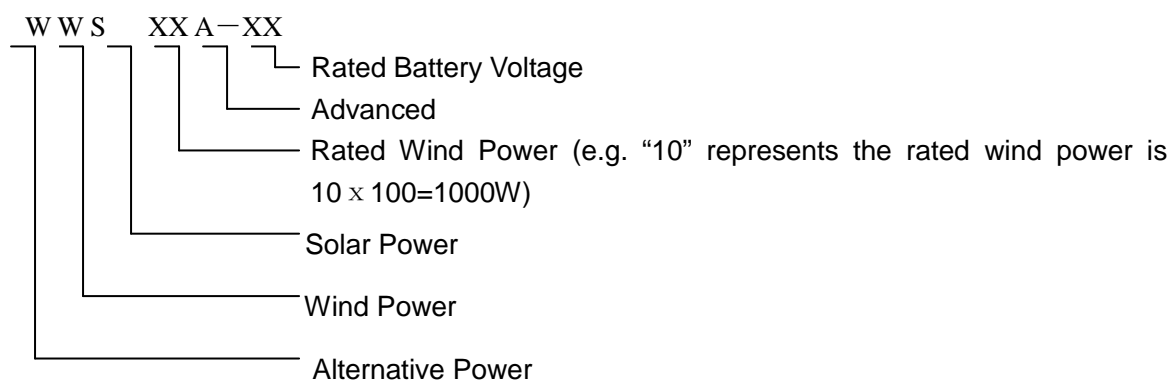

eg. WWS 10A-48 Advanced Wind/Solar Hybrid Controller, Battery Voltage is 48V)

3. Features

- Intelligently and modularized design, simple structure, powerful function, stable performance.
- PWM charging with voltage limiting and current limiting, users can set the stop rotation speed of fan precisely.
- Optional step-up charging module, the module's input impedance and the beginning charge voltage can be adjusted to suit the fixed feature of the different wind turbine.
- Optional RS232, RS485 interface output
- TVS lightning protection
- Using the LCD professionally designed for wind/solar hybrid street light .The LCD can displays all system status and system parameters with intuitive digital and graph.
- Perfect protection function.

4. Operational Regulations

The wind&solar hybrid system connection diagram a is as follows:

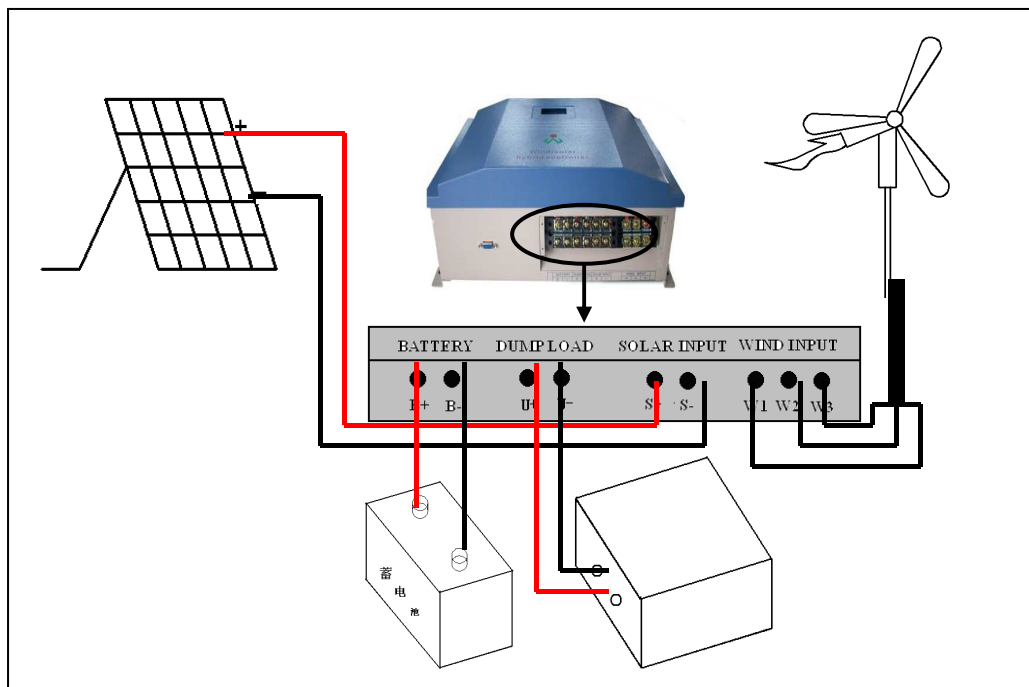

After wind/solar hybrid generator system and the various components of photovoltaic panels installed and the construction of the external circuit completed, the following order should be carry out to make the connection and operation safely and reliably.

- (1). Open the package and ensure whether the equipment is damaged due to transportation or not.
- (2). Connect the battery's positive pole to the positive (+) of "BATTERY" terminal, and connect the battery's negative pole to the negative(-) of "BATTERY" terminal with copper core cable(section surface $\geq 6\text{mm}^2$ and length $\leq 1\text{m}$). Despite the controller has the battery reversed protection, but reversing battery is still forbidden!
- (3). Make the wind turbine in brake status and then connect the output line of the wind turbine to the "WIND INPUT" terminal in back panel .
- (4). Cover the solar panel with a shelter and the connect the solar panels to the "SOLAR INPUT" terminal in back panel.
- (5). Install remote control software, then connect RS232 or 485 interface to computer by data connection. The computer will display the system parameters.
- (6). Users can check the parameters through the key of LCD.

5. LCD operation and Display Instructions



Picture 3, the key of LCD

5.1 Description of the Key:

Press any key, LCD backlight lights. The backlight will auto-off while stop pressing the key 10 seconds later.

- " $\uparrow(+)$ " key symbolizes increase or next one. In browsing window, press this key to display next parameter. Press this key to look the next parameter which can be modified or increase the value of the current parameter.
- " $\downarrow(-)$ " key symbolizes decrease or previous one. In browsing window, press this key to display the previous parameter. In setting window, press this key to look the previous





parameter which can be modified or decrease the value of the current parameter.

- "Enter" key symbolizes set or confirm key. In browsing window, press this key to access setting window. In setting window, press this key to save parameter and return to browsing window.
- "Esc" key symbolizes cancel or manual switch. In setting window, press this key to return to browsing window and do not save the modification. In browsing window, the key is as a manual reset key when the load short-circuit or overload occur.

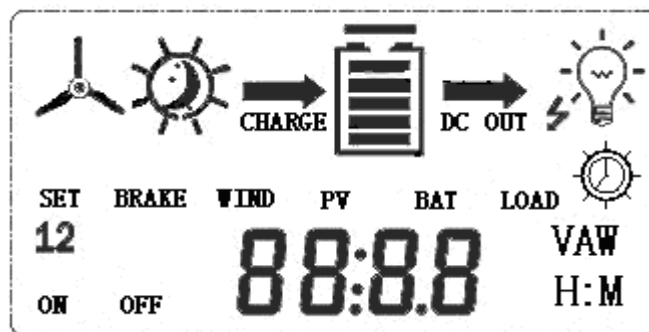
5.2 Displaying Contents Description

LCD screen displays the following picture.



- 1)  symbolizes the wind turbine.
- 2)  symbolizes the day,  symbolizes the moon.
- 3)  symbolizes the battery, internal strip graph represents the status of battery power. When the battery is full, 5 power bars in the battery box will show all the instructions. When the battery is over-voltage, the symbol  flashing, the flashing will not stop until over-voltage's recovering.
- 4) **88:88** is parameters showing. The LCD can displays system parameters with intuitive digital.

5.3 Browsing Parameters and Output Modes Description

- 1) Turn on the power, the LCD displays browsing window and battery voltage: XX. X V;
- 2) In browsing window, LCD will circularly display the following parameters by pressing " $\uparrow(+)$ " key, battery voltage, wind turbine voltage, photoelectric voltage, wind power, PV power, wind turbine current PV current and so on. LCD will display parameters in reverse order by pressing " $\downarrow(-)$ " key. (Notes: The controller just uses liquid crystal to display some

functions but not all of that.)

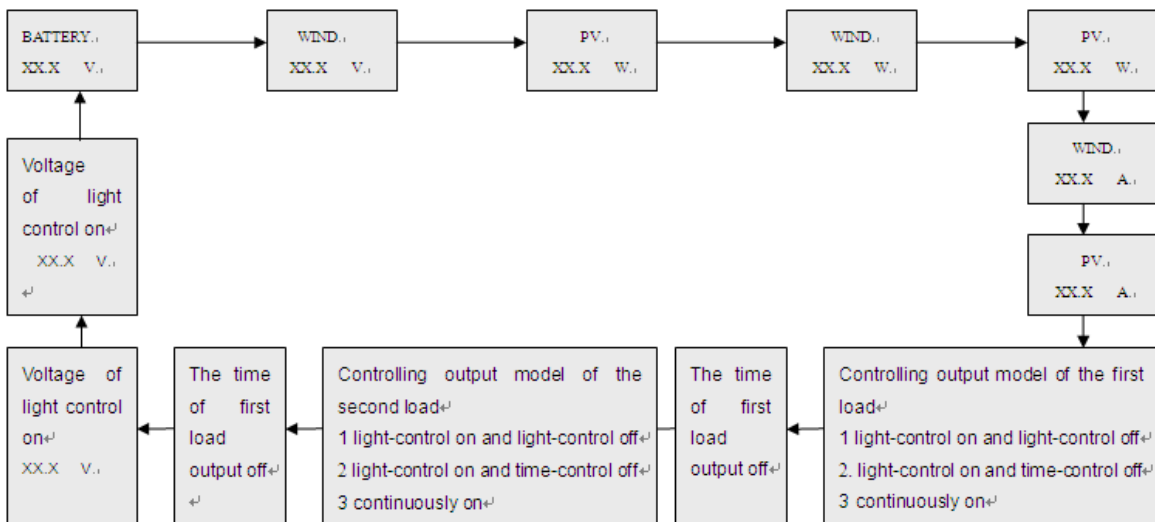

5. 4 Manual Brake Setting:

Press the "Enter" key and "Esc" key simultaneously, LCD displays the symbol **BRAKE** that suggests fan is in brake status. Press the "Enter" key and "Esc" key simultaneously in brake status, the symbol **BRAKE** will disappear and the brake status is released. In normal situation, the fan can not be set in brake status.

6. Control Software

Process one: Software Installation

Double-click "WinController.exe" file → click "Install" → read the agreement of license, click **【I agree】** if users agree to the terms and conditions → **【Next】** ... → **【Success】** .

(Software installation process is same as general software installation process)

Process two : Usage of the software

1. The choice of serial port

By default, the serial port is COM1, the 9-needles serial port back in the general desktop is COM1. Connect the RS232 interface of the controller to COM1 serial port of the computer with serial cable(If it is RS485, you need is a RS485 converter RS232 , and then connect it to COM1). Connect the controller's power supply, then open the software and complete the connection. After the connection, the light in bottom-right corner of the software is green and the status bar up the light displays "Normal". If your computer is not COM1 ,you can set it by the following step.

① Firstly, identify your computer's serial port : Right-click "My Computer" → "Properties" → "Hardware" → "Device Manager" → "Ports"; check your serial port.

② Open the software, click "Set" menu→ "serial port", popup the dialog box and select your serial port ;

Graphic Displaying Instruction:

- Chart P-T shows the relationship between power and time , the horizontal axis represents time T, the vertical axis represents power W.
- Chart U-T shows the relationship between voltage and time , the horizontal axis represents time T, the vertical axis, said power U.
- Chart P-T / U-T is a polar chart of power -time and voltage-time. The chart shows the date and the time at the same time.

The interface of the software instruction



Parameters Displaying Instruction:

- The first column displays battery's parameters , followed by current, voltage, power, quantity of electricity .
- The second column displays solar energy's parameters , followed by current, voltage, power, quantity of electricity.
- The third column displays the wind turbine's parameters , followed by current, voltage, power, quantity of electricity.
- The bottom- right corner shows the light and the speed of fan. The light shows yellow and character “No Signal” when there is no signal, green and character “Normal” when there is signal, red and character “Unload” when controller is unloading, red and character “Low Battery” when battery is low voltage.

The interface displays the speed of fan when the system works well .

Menu Bar Instruction:

- Viewing, saving and deleting of power

(1) "File" → "The month consumption" (to see the electricity of the month)

(2) "File" → " Inquire electricity" (to see the previous electricity)

(3) "File" → "Save electricity" (to save the electricity of the month)

(4) "File" → "Delete the electricity of the month "

● "Set" menu

(1)"set" menu→"Serial port" menu, select the port

(2)"set" menu→"Background" menu , set the company name and main form.

(3)"set" menu→"scale" menu, set the scale of P-T curve and U-T curve

(4) "set" menu→"speed of fan"menu, select "fan speed showing" or "no fan speed showing"

(5) "set" menu→"system selection", select 12V system or 24V system in "controller system" bar and select Chinese-English or English LCD display interface in "LCD interface".

● "View" menu

Users can select which curve will be displayed in the pull-down menu of "View" menu. There are battery curve, solar curve, wind energy curve or all three showing at the same time .

● "Parameter" menu

(1) "Parameter" menu → "Set" menu.(Users can set or modify the unload voltage point, unload current point, RMP of fan stop, input impedance range and initial charging voltage. Password is needed when modify the parameters and factory default is 123456.)

(2) "Parameter" menu → "Control" menu.(It can control the wind turbine).

Notes: Password is needed when modify the parameters . Enter the password and click "OK" twice, when there is "set successfully", setting parameters is succeed, otherwise it should be reset.

7. Parameters

Model	WWS10A-48
Rated Battery Voltage	48V
Rated Wind Turbine Voltage	56VDC
Rated Wind Turbine Maximum Power	1000W
Input Impedance Range (factory default)	2~30Ω adjustable (6Ω)
Rated Wind Turbine Maximum Input current	0~40A

Rated Wind Turbine Maximum instantaneous Input current	2000W
Wind Turbine Charge Voltage(factory default)	Continuous Adjustable (8V)
Unload Voltage (factory default)	52v~60V adjustable (54V)
Unload Current (factory default)	0~20A adjustable (18A)
Wind Turbine over Speed(factory default)	0~600rpm adjustable, recover automaticly 10 minutes later (500rpm)
Rated PV Maximum Power	600W
Rated PV Rated Voltage	68V
PV maximum charge Current	10A
Temperature Compensation	-5mv/°C/2V (Over-Discharge Protection, over-discharge recovery voltage unload voltage compensation)
Control Mode	PWM
Display Mode	LCD
Display Parameters	Battery Voltage, Wind Turbine Voltage, PV Voltage, Wind Turbine Current, PV Current, Wind Turbine Power, PV Power .Etc
Communication Interface Module	RS-232C (RS485 is selection)
Range of working Temperature & Humidity	-20~+55°C/35~85%RH (Without Condensation)
Quiescent Current	20±2 mA (100mA if the interface is RS485)
Protection Type	Solar cells reverse charging, solar cells anti-reverse, battery over charge, battery over-discharge, battery anti-reverse, Overloading, lightning protecting, wind turbine current limiting, wind turbine automatic brake and manual brake.

8. Abnormal phenomenon and treatment

Phenomenon	Description
The symbol  flashing, without charge or discharge	Battery is over-voltage, check battery voltage, and the cable is connected or not, reconnect all components;
LCD controller always displays "brake (BRAKE)", and the manual can not cancel	a) First of all, "Parameter" menu → "Control" menu through the software, to see if set to "brake" , cancel the brake status. b) Brake state is usually caused by over-speed of wind turbine. It will automatically return to normal after 10 minutes under normal circumstances. c) If not the above, first disconnect the fan and controller, and then disconnect the battery and controller . After a few minutes to start re-wiring work, observing whether it has returned to normal.

If the phenomenon do not meet the description or can not return to normal, please contact our service department or salesman to repair or replace.