

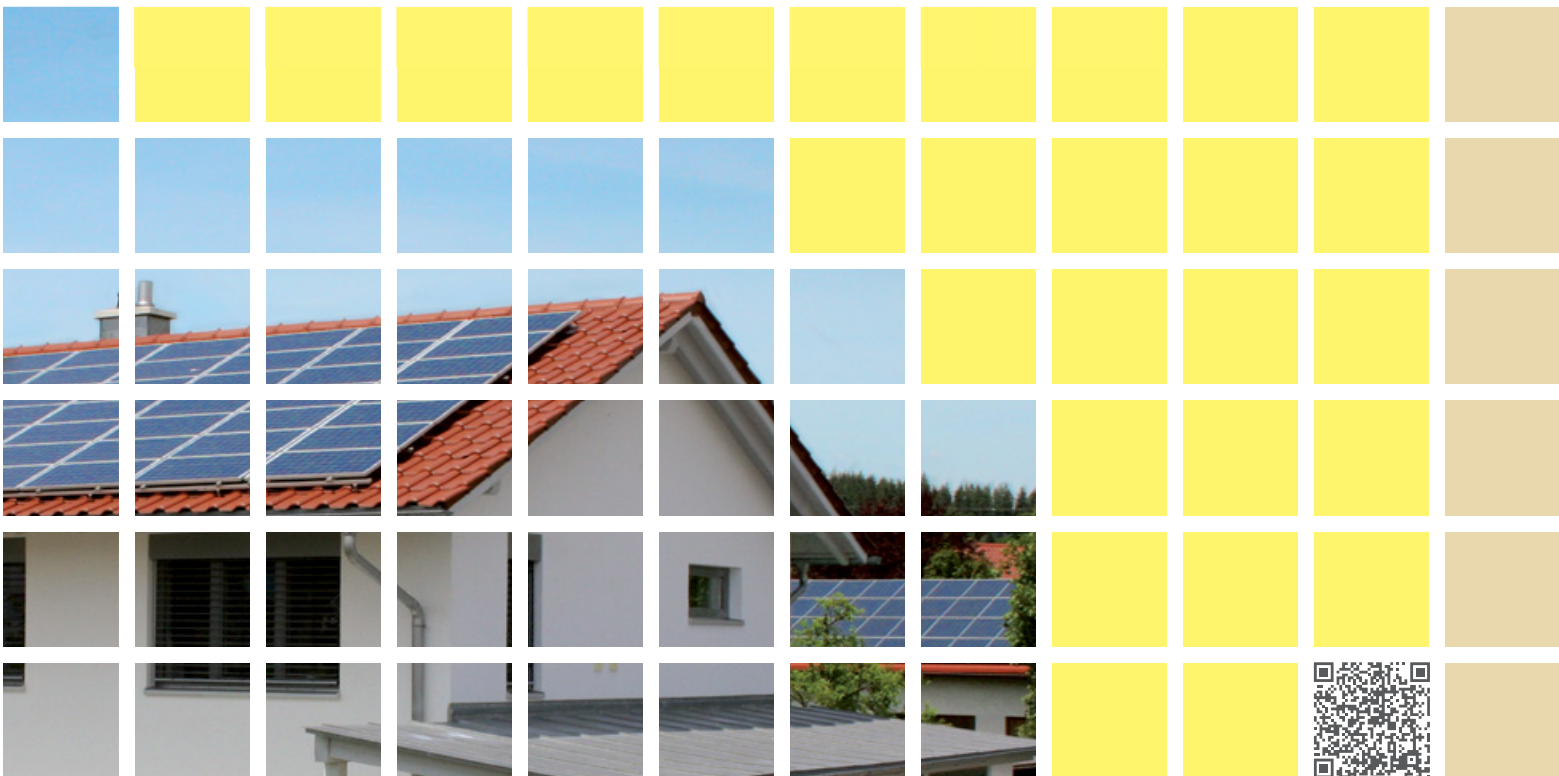

Quality made
in Germany



PV GRID CONNECTED





»POWER FROM THE SUN FOR EVERYDAY USE.«

In one hour, the amount of energy radiated to the earth by the sun exceeds the annual energy requirement of the world population. Making use of this inexhaustible energy source for our everyday electricity requirement is the great challenge of the present and the future. Steca was quick to recognise the opportunities of a boom in the making: The company has become synonymous all over the world with vision, innovation, and initiative in the name of solar power. Steca is a recognised specialist in the development of high-performance systems which turn light into electricity before feeding it into the public grid.

CONTENT

4 STECA



7 SYSTEM OVERVIEW

8 Small systems



10 Systems for difficult roofs



12 Residential systems



14 Commercial systems



16 Steca SolUse Expert



19 PRODUCTS

20 StecaGrid 300 / 500



24 StecaGrid 2000+ / 2010+



28 StecaGrid 2020 / 3000 / 3600 / 4200



34 StecaGrid 8000+ 3ph / 10000+ 3ph / 8000 3ph / 10000 3ph



41 SYSTEM MONITORING AND ACCESSORIES

42 System monitoring



52 Accessories



53 Software



56 SERVICE
59 OTHER PRODUCT AREAS



Exclusion of liability

Steca Elektronik GmbH reserves the right to supplement and change the product range offered in the catalogue, or to remove products from the range. Please contact Steca if you require additional or more up-to-date product information. The information in this catalogue is not exhaustive. We compiled this information with care. In spite of this, it may not have been updated or may no longer be applicable in individual cases. We accept no liability for imprecise or missing information in this catalogue.

Copyright Steca Elektronik GmbH („Steca“). Steca is a protected trademark of Steca Elektronik GmbH. This trademark may only be used by third parties with our express prior permission. The sole owner of the rights to the images and logos and texts is Steca. Steca allows the free use of product pictures and graphics in the context of the presentation of its own products, as long as neither product pictures nor graphics are altered or edited, in particular with regard to cropping, modification, distortion or other deformations. The permission of Steca must always be gained for any other commercial use. „Steca Elektronik GmbH“ must always be indicated as the source of the images. In return for the provision of the pictures free of charge, Steca requests a sample copy when they are used in print media, and a brief notification when they are used in film and electronic media. You agree that this agreement does not require a signature in order to become valid. The pertinent laws of the Federal Republic of Germany apply for the use of this catalogue by third parties and the use of the corresponding terms and conditions.

Images from Steca, www.burger-fotodesign.de, www.photocase.com and www.marx-studios.de, www.fotolia.com, www.istockphoto.com.

»WE ARE THINKING OF TOMORROW.«



Environmental protection in series



»Simple business processes, fair partnerships and transparent communication contribute to our joint success.«



Services and production have an ecological future at the Memmingen electronics specialist company Steca. The company makes a worldwide contribution to reducing power consumption and allowing alternative energy sources to be used efficiently by providing high-performance products.

Steca has established a wide base in order to achieve these goals. The company offers electronic services for residential, automotive, agricultural, environmental, traffic and building technology and also for the industrial and medical sectors. The company also develops products for the environmentally friendly use of solar energy under the brand name of Steca. Steca Elektronik is one of the few manufacturers that cover all three segments of the solar market: PV grid feeding

systems, off-grid PV systems and solar thermal systems. Steca also produces battery charging systems that extract the maximum potential from the energy storage system.

Steca sets a good example in its own production methods: the company uses only manufacturing processes that conform to strict ecological criteria. Steca is actively involved in research projects for efficient energy use and climate protection. In 2007, the German federal government therefore listed Steca as an authority for energy generation in the environmental technology atlas „Green Tech made in Germany“.

Steca's environmental policy is based on sustainability and environmental compatibility, with a view to providing services and producing products for an ecological future.

The company considers the whole value-added chain from this perspective and also involves its suppliers and customers. Steca is certified in accordance with ISO 14001:2004 and organised in accordance with the EU Environmental Management and Audit Scheme.



Full power for you: Management board Michael, Dietmar and Peter Voigtsberger

»MAXIMUM FLEXIBILITY FOR MAXIMUM RESULTS.«

Whether being used in a small solar power system for a single-family house, or an elaborate combined solution for an industrial complex, Steca grid-feeding inverters all have one thing in common: They offer the highest performance along with maximum flexibility and ease of use. The modular concept offers you over 100 different possibilities for designing an inverter system tailored to your individual needs. Steca always offers you the optimal inverter for your system.

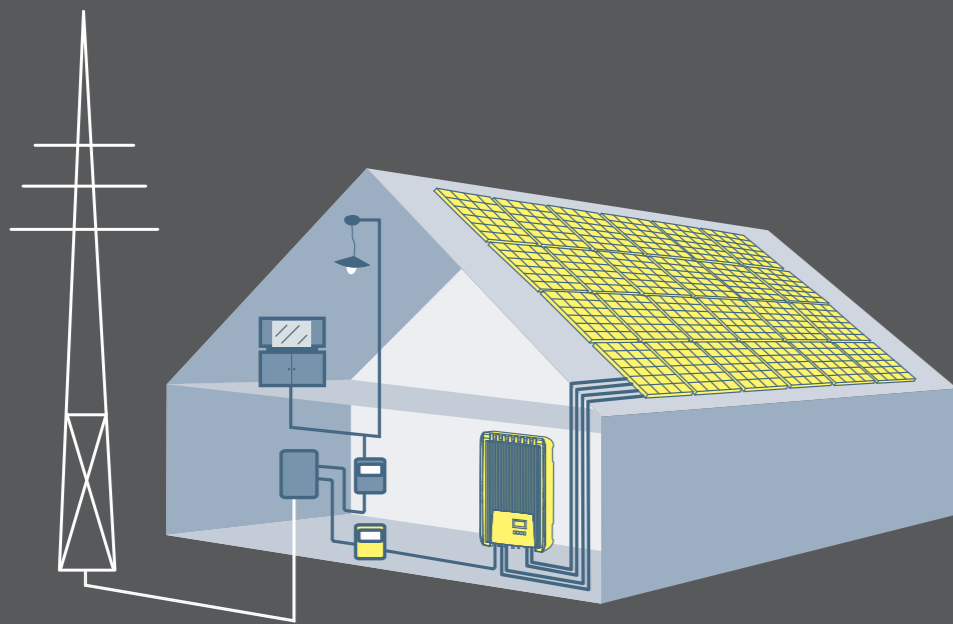

SYSTEM OVERVIEW

- Small systems 
- Specialists in difficult roofs 
- Residential systems 
- Commercial systems 
- Steca SolUse Expert 



SMALL SYSTEMS

Residential settlements, carports and garages

Photovoltaic systems are still highly efficient in small-scale systems. Especially on garages and carports, but also on residential settlements, a small investment can produce remarkable yields.

Internationally connected to the grid

In several countries, small-scale photovoltaic systems are specially subsidised – StecaGrid inverters are the first choice for these types of system.

Maintenance-friendly small-scale inverter solution

An efficient photovoltaic system can be implemented with only a small number of modules. The arguments speaking for small-scale systems are high performance and maintenance-friendliness.

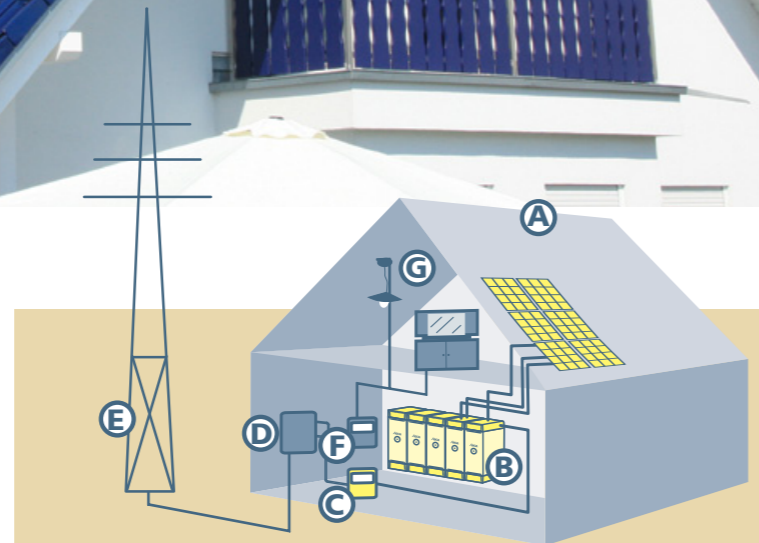

Key:

- A Solar modules
- B Grid inverter
- C Grid-feed electricity meter
- D House connection point
- E Public electricity network
- F Consumption electricity meter
- G Electrical load

Overview of devices:



StecaGrid 300 and StecaGrid 500

Grid inverter
300 W - 3,600 W
(from page 20)





Differently oriented roof surfaces and shading

SYSTEMS FOR DIFFICULT ROOFS

Differently oriented roof surfaces and shading

What is the point of having the largest, south-facing, optimally inclined 30° roof surface, if a neighbouring building, a tree, a street lamp, or even the roof's own chimney casts its shadow on the new solar energy system? That's like driving with the hand-brake on!

Shadows waste money

As the weakest solar cell determines the total output of a whole module, even the shadow of a roof antenna can reduce the yield of a PV system by up to 20 percent!

Thus, before installation, it is important to ascertain what objects in the system's surroundings can cause shading and to dimension the system accordingly.

As a specialist in situations of this kind, Steca develops individual solutions.

First choice for thin-film modules

The occurrence of discharge current in a PV system is unavoidable. In the case of thin-film modules, this can lead to long-term damage and efficiency losses.

The solutions to this problem are inverters with an integrated transformer: StecaGrid 2000+ and StecaGrid 2010+ with in-built transformer offer security at 95% efficiency!

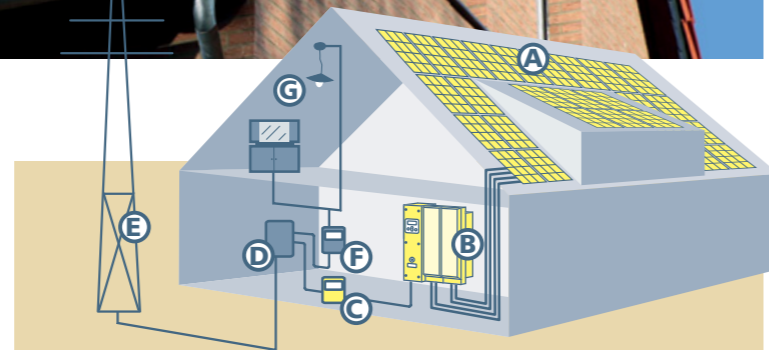

Key:

- A Solar modules
- B Grid inverter
- C Grid-feed electricity meter
- D House connection point
- E Public electricity network
- F Consumption electricity meter
- G Electrical load

Overview of devices:



StecaGrid 2010+
Grid inverter
2,000 W up to several 10,000 W
(from page 24)

not shown:
StecaGrid 2000+



StecaGrid Connect User
User interface
(page 45)



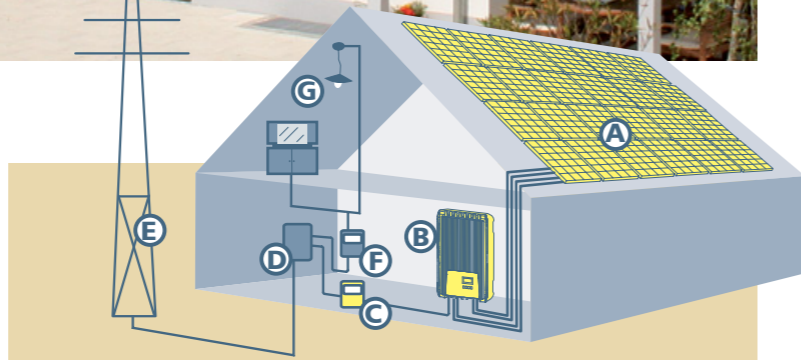

Key:

- A Solar modules
- B Grid inverter
- C Grid-feed electricity meter
- D House connection point
- E Public electricity network
- F Consumption electricity meter
- G Electrical load

RESIDENTIAL SYSTEMS

Single-family houses and apartment buildings

PV to provide for one's old age

Whether feeding into the public grid, or just for your own use, the roofs of single-family houses and apartment buildings can become true „profit roofs“. Photovoltaic systems in this market segment are one of the best ways of providing for your old age.

Solar power provides independence

Independence from the pricing arrangements of the large energy producers. Independence from energy policy in crisis countries, for instance in the Middle East. And last but not least: independence from the power outage risk of large electricity suppliers.

Photovoltaics are decentralised

Solar power is generated right where it is needed. This means: no energy losses and no costs for transmission and distribution.

Simply generate electricity yourself!

In addition to standard single-family houses, garages, carports and the roofs of apartment buildings are also suitable for electricity generation. The electricity is distributed locally throughout the settlement via the low voltage grid. Here, there is a need for solutions adapted to the individual situation. Optimal yield with easy care and handling are criteria which count for the operators.

Overview of devices:



StecaGrid 2020, StecaGrid 3000, StecaGrid 3600 and StecaGrid 4200
Grid inverter
3,000 W up to several 10,000 W
(from page 28)

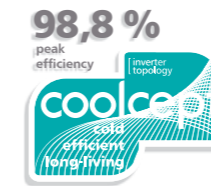

StecaGrid Vision
Display unit
(Page 47)

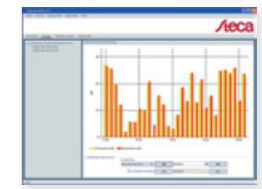

StecaGrid User
Visualisation software
(Page 46)



Meteocontrol WEB'log and Meteocontrol WEB'log Comfort
Data logger and Meteocontrol Web'log web portal
(Page 50 and 51)



Solar-Log 500/1000™
Data logger and Solar-Log™ Web Html user interface
(Page 48)



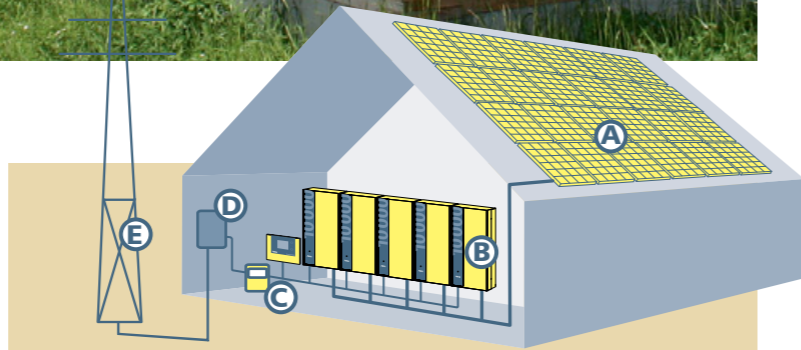

Key:

- A Solar modules
- B Grid inverter
- C Grid-feed electricity meter
- D House connection point
- E Public electricity network

COMMERCIAL SYSTEMS

Industry, agriculture and ground-mounted installations

Solar energy systems are not only ecologically worthwhile and financially profitable – thanks to the feed-in tariffs which are legally guaranteed in numerous countries, they are one of the most secure capital investments worldwide: thus, an ever-increasing number of systems are being realised by commercial investors and investment funds.

Your yield always in view

Systems in this segment are installed on commercial buildings, agricultural buildings, or on the ground.

In such cases, however, the system operator is often not the owner of the roof or surface. This in turn calls for professional remote system monitoring. In the event of a fault, an automatic alarm must immediately notify the system operator and possibly the installer as well.

Overview of devices:



StecaGrid 8000 3ph, StecaGrid 10000 3ph
Grid inverter
8,000 W up to several 1,000,000 W
(from page 34)



StecaGrid 8000+ 3ph, StecaGrid 10000+ 3ph
Grid inverter
8,000 W up to several 1,000,000 W
(from page 34)



StecaGrid Vision
Display unit
(Page 47)



StecaGrid User
Visualisation software
(Page 46)



Meteocontrol WEB'log and Meteocontrol WEB'log Comfort
Data logger and Meteocontrol Web'log web portal
(Page 50 and 51)



Solar-Log 500/1000™
Data logger and Solar-Log™ Web Html user interface
(Page 48)



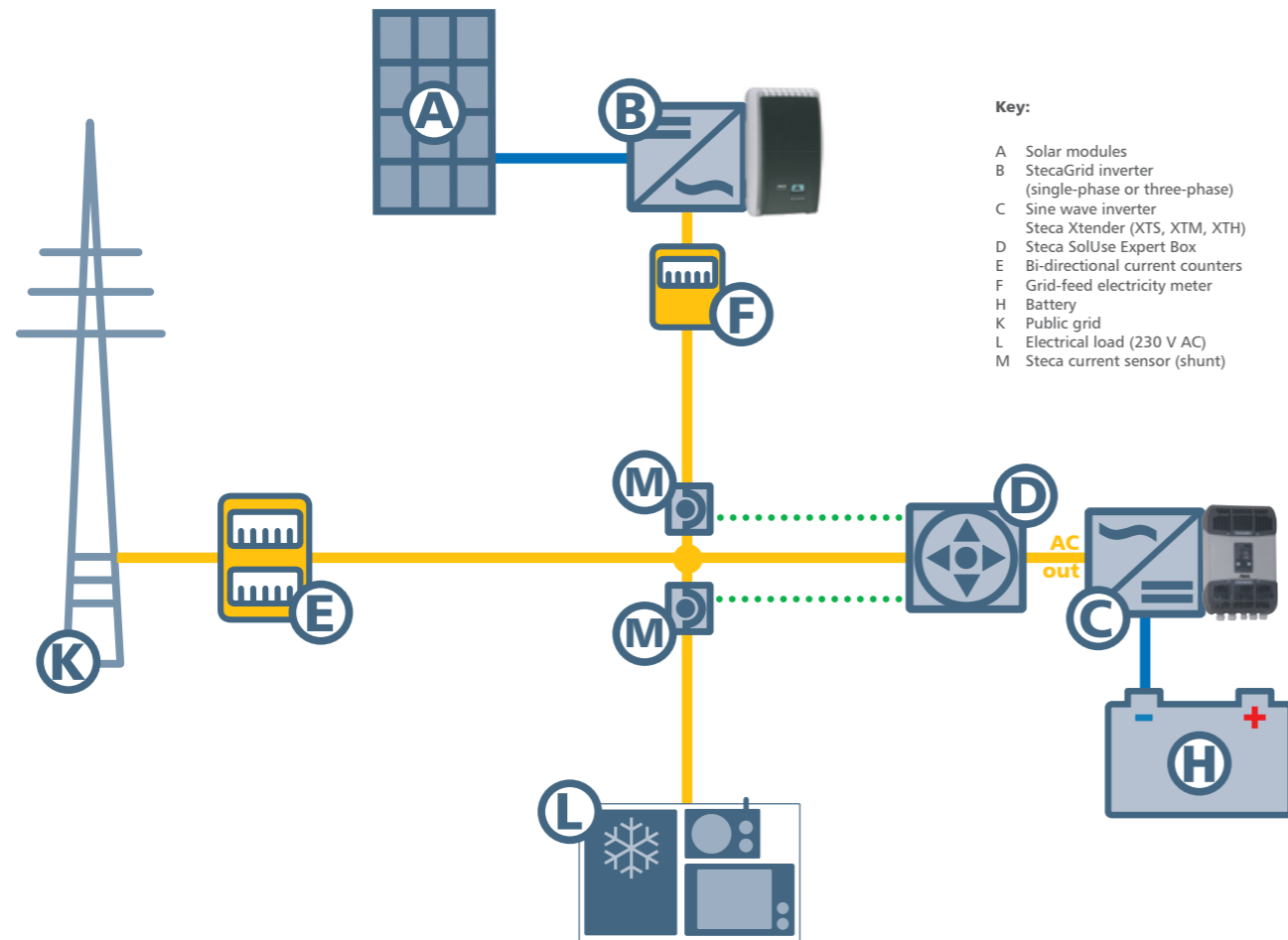

STECA SOLUSE EXPERT

System optimising by increasing own consumption

The Steca SolUse Expert system is both a standard grid-connected system and an autonomous, battery-supported photovoltaic (PV) system.

If PV systems are installed in areas in which a public grid is available, while at the same time, feeding is not desirable due to local conditions or an unsuitable remuneration situation, the own consumption share of the PV power should be as large as possible.

The Steca SolUse Expert system is ideally suited to this purpose: The grid-connected system is extended by a battery bank and a bi-directional Steca Xtender (XTS, XTM or XTH) stand-alone inverter. A cleverly designed operation management strategy optimises the energy flow according to requirements. In this way, users with this system can ensure that the PV power generated in the system is to a large extent consumed in the system itself. The energy exchange with the public grid is minimised. This results in major cost savings.

The Steca SolUse Expert system consists of a PV generator with StecaGrid grid inverter (B), a bi-directional battery inverter (C), a battery bank (H) and the Steca SolUse Expert Box (D). The entire system is controlled by the Steca SolUse Expert Box (D). The information relating to the current output of the grid inverter (B) and the level of the load (L) required is provided by two Steca PS HS200 (M) current sensors.

The aim of the control system is to minimise the energy flow via the bi-directional counter (E). Ideally, the current flowing through the counter (E) is always zero.

Usually, all components are in operation. If the current feed output of the PV system is higher than the total of all loads (L), precisely the level of the excess energy is stored in the battery bank (H) via the bi-directional battery inverter (C). In this case, the current flowing through the counter (E) is zero. If the battery bank (H) is fully loaded, the excess current in the system can no longer be used and is fed into the public grid (K) via the counter (E). The battery bank (H) is here maintained precisely at its necessary end-of-charge voltage.

As soon as the total of all the loads (L) is higher than the current feed output of the PV system, the necessary energy is provided via the bi-directional battery inverter (C) and the Steca SolUse Expert Box (D) from the battery bank (H). Only so much output is discharged from the batteries (H) as to ensure that the loads (L) can be fully supplied and the current flowing through the counter (E) is zero. Only when the minimum battery voltage has been reached is the discharge current from the battery bank (H) reduced by the Steca SolUse Expert Box (D). In order to prevent a deep discharge of the battery, the Steca SolUse Expert Box (D) can also reduce the discharge current to zero. The difference required in order to supply the load is in this case drawn from the public grid (K) via the counter (E). If the lower voltage limit of the battery bank (H) has been reached, the bank is charged via the output of the PV system. During longer periods with a low output from the PV system, the battery bank can as an option also be manually recharged via the public grid (K) and the counter (E), in order to prevent the battery bank (H) from remaining in deep discharge for a long period of time.

Overview of devices:



Steca Xtender XTS
Sine wave inverter
1,000 W - 12,600 W
(Steca PV Off Grid)



Steca Xtender XTM
Sine wave inverter
1,500 W - 36,000 W
(Steca PV Off Grid)



Steca Xtender XTH
Sine wave inverter
3,000 W - 72,000 W
(Steca PV Off Grid)



Steca RCC-02
Remote control and display
(Steca PV Off Grid)



Steca SolUse Expert Box



StecaGrid 300 and StecaGrid 500
Grid inverter
300 W - 3,600 W
(from page 20)



StecaGrid 2010+
Grid inverter
2,000 W up to several
10,000 W
(from page 24)



StecaGrid 3600
Grid inverter
3,000 W up to several
10,000 W
(from page 28)



StecaGrid 10000+ 3ph
Grid inverter
10,000 W up to several
1,000,000 W
(Page 34)



Steca X-Connect system
Prewired mounting structure
for devices from the Steca
Xtender XTH series

not shown.:
StecaGrid 2000+

not shown.:
**StecaGrid 2020,
StecaGrid 3000,
StecaGrid 4200**

not shown.:
StecaGrid 8000+ 3ph

SolUse Easy

Thanks to the SolUse Easy system, the own consumption share of the PV power can be raised substantially. Requiring no batteries, it represents a cost-effective alternative to the SolUse Expert system. If sufficient PV power is available, up to 12 consumers can be switched

on and priority status and minimum durations can be defined. SolUse Easy has been designed for resellers who wish to integrate this control into their system.

Full flexibility with practical functions make the Steca SolUse Expert system stand out:

Installation

One key advantage of the Steca SolUse Expert solution is the high degree of flexibility of the system. The battery section of the system – the Steca SolUse Expert Box (D), the Steca Xtender battery inverters (C) and the battery bank (H) – can be installed completely separately from the actual PV grid feed system. Since both system sections are continuously connected to the same grid, they do not have to be installed at the same site. The Steca SolUse Expert system can simply be connected using an existing plug or installation node. Installation is simple: The Steca SolUse Expert Box contains all the components you need and is delivered ready for installation. The box is connected to the battery bank on the DC side. The AC input is connected to the local grid node, while the AC output is connected to the Steca Xtender. There is no further need to configure the system.

Retrofitting and dimensioning

A Steca SolUse Expert system can be retrofitted to every existing grid-connected PV system. In general, no consideration of the size of the components is required, since these operate fully autonomously and independently of one another. This important feature makes it possible to slightly increase own consumption with very small, low-cost systems. It is also possible to increase own consumption up to a maximum level with a larger system.

Battery type

The Steca SolUse Expert systems can be operated with all lead-based battery types with fluid and fixed electrolytes. The system can also be operated with Li ion batteries (LiFePo4). The battery voltage remains at 48 V.

MSD

The Steca SolUse Expert box contains an MSD and can therefore be directly connected to any grid node.

Backup option

Every Steca SolUse Expert system has as an option an AC backup output on the output side of the Steca Xtender. As a result, an emergency power supply is available when the power fails. The output of this supply is limited to the maximum output of the Steca Xtender used. The maximum level of energy which can be used is limited by the residual capacity in the battery.

AC connection

Every Steca SolUse Expert system is in general delivered as a three-phase model and can be used as a single-phase or three-phase system. If the owner wishes to optimise the system to own consumption in a three-phase manner, 3 Steca Xtenders are required. Each Steca Xtender then regulates one phase.

» HIGHEST PERFORMANCE ALONG WITH MAXIMUM FLEXIBILITY AND EASE OF USE«

Together with their range of accessories, StecaGrid inverters represent an innovative family of inverter solutions for grid-connected solar power systems.



PRODUCTS

StecaGrid 300 / 500



StecaGrid 2000+ / 2010+



StecaGrid 2020 / 3000 / 3600 / 4200



StecaGrid 8000+ 3ph / 10000+ 3ph /
8000 3ph / 10000 3ph





StecaGrid 300/500

modular and flexible

The StecaGrid 300 and StecaGrid 500 inverters are perfectly suited to smaller solar power systems starting at 300 W. Thanks to the modularity, this is the inverter of choice in systems with differently aligned or partially shaded roofs, and on smaller surfaces (garage roofs, summer houses).

The inverters StecaGrid 300 and StecaGrid 500 were developed to make the use of solar energy as simple as possible. They are simple to install, easy to expand, and can be optimally adjusted to suit the local irradiation conditions.



STECAGRID 300 BEST IN TEST!

Most efficient inverter

The StecaGrid 300 inverter was the top performer in a test of small grid-connected inverters and solar modules conducted by the renowned Paul Scherrer Institut in Switzerland. The testers determined that the test winner from the Memmingen-based Steca solar electronic company was the most efficient in its class. According to study data, the efficiency of the StecaGrid 300 rises relatively quickly and remains at a constantly high level. It won the top spot among the tested devices with 93.5 per cent.

The StecaGrid 500 was also awarded high marks in the test. This was confirmed in a report by the Swiss trade journal „Erneuerbare Energien“ („Renewable Energy“) on the efficiency of solar power systems. In the December 2007 issue the journal came to the conclusion that „according to our measurements the StecaGrid inverters were clearly the best performers.“ The test report of the Paul Scherrer Institut can be downloaded at http://tpv-pv.web.psi.ch/grid_pv.pdf The StecaGrid 300 and 500 have not just proved to be particularly efficient; they also stand out with their flexibility. The modularity of MiniString inverters makes them ideal for garages, carports, terraced and single-family houses. Moreover, due to the short strings and numerous MPP trackers, they are very well suited for small-section or partially shaded roofs.



StecaGrid 300 and StecaGrid 500

The inverters series comprises the StecaGrid 300 and StecaGrid 500 inverters, with rated outputs of 300 W and 500 W, respectively.

StecaGrid 300 and StecaGrid 500 are built in a modular manner, and simple to install. With distribution over three phases, the system can at any time be expanded as desired, and thus flexibly adapts to your solar power system investment. StecaGrid 300 and StecaGrid 500 have an independent MPP tracker and achieve a very high efficiency of up to 95.8 %.



Product features

- Flexible and expandable
- High efficiency
- Low weight
- Simple installation
- Wall-mounting with top-hat rail

Displays

- Multi-coloured LED shows operating status

Options

- United Kingdom variants as per G83 available
- Italy variants available
- Spain variants available

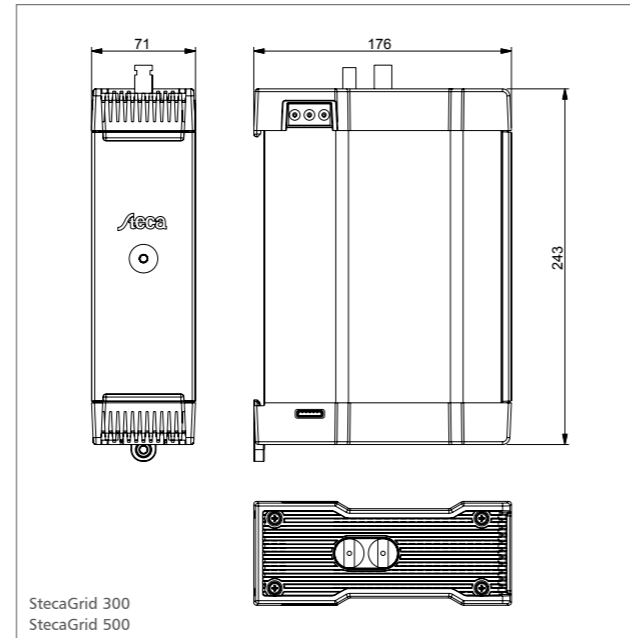

StecaGrid 300
StecaGrid 500

System monitoring and accessories



StecaGrid ALD1
Digital energy meter
(Page 44)



DC circuit breaker
(Page 52)

	StecaGrid 300	StecaGrid 500
DC input side (PV-generator)		
Maximum start voltage	135 V	230 V
Maximum input voltage	135 V	230 V
Minimum input voltage	45 V	
Minimum input voltage for rated output	64 V	106 V
MPP voltage	45 V ... 100 V	45 V ... 170 V
Maximum input current	5 A	
Maximum input power at maximum active power	320 W	530 W
Maximum recommended PV power	375 Wp	625 Wp
AC output side (Grid connection)		
Grid voltage	185 V ... 276 V (depending on regional settings)	
Rated grid voltage	230 V	
Maximum output current	1.5 A	2.5 A
Maximum active power (cos phi = 1)	300 W	500 W
Rated power	300 W	500 W
Rated frequency	50 Hz	
Frequency	47 Hz ... 52 Hz (depending on regional settings)	
Night-time power loss	0 W	
Feeding phases	single-phase	
Distortion factor (cos phi = 1)	< 6 % (max. power)	< 5 % (max. power)
Power factor cos phi	1	
Characterisation of the operating performance		
Maximum efficiency	94.8 %	95.8 %
European efficiency	93.4 %	94.5 %
MPP efficiency	99 %	
Power derating at full power	from 40 °C	
Standby power	0 W	
Safety		
Isolation principle	no galvanic isolation, transformerless	
Grid monitoring version StecaGrid 300 UK resp. 500 UK	voltage (230 V +15 %/-10 %) frequency (50 Hz +0.5 Hz/-3 Hz)	voltage (230 V +15 %/-10 %) frequency (50 Hz +0.5 Hz/-3 Hz)
Grid monitoring version StecaGrid 300 ES resp. 500 ES	voltage (230 V +10 %/-15 %) frequency (50 Hz +/-1 Hz)	voltage (230 V +10 %/-15 %) frequency (50 Hz +/-1 Hz)
Grid monitoring version StecaGrid 300 IT resp. 500 IT	voltage (230 V +/-20 %) frequency (50 Hz +/-0.3 Hz)	voltage (230 V +/-20 %) frequency (50 Hz +/-0.3 Hz)
Operating conditions		
Area of application	indoor rooms, with or without air conditioning	
Ambient temperature	-20 °C ... +45 °C	
Relative humidity	0 % ... 95 %	
Noise emission	< 32 dBA	
Fitting and construction		
Degree of protection	IP 20	
Overvoltage category	III	
DC Input side connection	Multi-Contact MC 3, MC 4	
AC output side connection	Stecker Wieland Electric GST 18i3V	
Dimensions (X x Y x Z)	176 x 243 x 71 mm	
Weight	1.4 kg	
Communication interface	no	
Integrated DC circuit breaker	no	
Cooling principle	natural convection	
Test certificate	CE mark, DK 5940, G83, RD1663	





StecaGrid 2000+ StecaGrid 2010+ for universal use

StecaGrid 2000+ and StecaGrid 2010+ are designed for solar power systems from 2,000 W upwards. These inverters are also the first choice in situations where the roof conditions are difficult, such as partially shaded or differently aligned roof surfaces. For the home owner and for the farmer.

A master can be supplemented by one or two additional slaves, so that inverter units with 4,000 or 6,000 W can be realised. Several master-slave combinations can be used within a single system.



StecaGrid 2010+ D Master and 2 StecaGrid 2010+ Slaves



8.2 % MORE PROFIT IN THE EVENT OF SHADING, due to a cleverly connected StecaGrid 2000+ inverter

Steca has further underlined its position as a specialist in difficult roofs. A simulation, which an independent institute was commissioned to conduct, showed that in shaded locations, the inverter StecaGrid 2000+, with four MPP trackers, feeds 8.2 percent more electricity into the grid each year than an inverter with one MPP tracker.

The test setup was realised on a roof, on which a dormer cast its shadow on the generator surface in the mornings and evenings. The company Solarschmiede, responsible for the simulation, assessed two 4 kW systems. In the first, the staff connected a 4,040 W (DC) inverter with a single MPP tracker for three parallel strings. In the second system, they installed the StecaGrid 2000+ with four MPP trackers – one for each of the four inputs. Even in the absence of shading, the Steca inverter's decrease in yield compared to the conventional system was just 1.7 percent. The simulation showed that if shading does occur, using the Steca inverter really pays off. With 8.2 percent more yield per annum, even installations on difficult roofs become profitable.

And one thing is clear: site-specific shading is caused not only by dormers, but also by neighbouring buildings, chimneys, trees, masts or antennas.

Up to 6 kW, the user benefits from the Steca system's unit, which is more compact than conventional systems with four individual devices: one display and one AC connection on the grid side guarantee lower procurement and maintenance costs.

► Download report at www.stecasolar.com

StecaGrid 2010+: Master-slave combination



Simulation and analysis of a shading situation for a grid-connected PV system by order of Steca Elektronik GmbH.



StecaGrid 2000+
Master and Slave

Summary of results and conclusion

The analysis of the two provided connection schemes for 27 example modules with two StecaGrid 2000+ inverters (Master and Slave) and one example string inverter (hereinafter referred to as ESI) produces the result which is to be expected. In the absence of shading, the ESI achieves an almost 2% higher yield than the two StecaGrid 2000+ inverters, due to its higher efficiency. In the actual case in question, in which a dormer casts a shadow on the generator surface in the mornings and evenings, the StecaGrid 2000+ inverters (which use multi-MPP trackers) achieve a higher yield than the ESI (which uses 1 MPP tracker for 3 parallel strings). With an annual energy yield of 4,189.6 kWh, they could feed around 8.2 % more energy into the grid than the ESI (3,872.2 kWh)¹. This difference is due to the ESI's universal shifting of the MPP point in the event of shading. With an approximately 8.2 % higher yield, the connection scheme with the StecaGrid 2000+ inverters clearly shows that the use of a multi-MPPT inverter is worthwhile in the event of shading, even if the difference in efficiency is greater than that of the two tested inverters. Furthermore, the fact that in this shading situation the StecaGrid 2000+ inverters achieve a yield which is only 1.7 % lower than in the absence of shading, is indicative of the shading tolerance of the multi-MPPT inverters.

However, it must also be noted that the mismatch losses of the string (ESI) in which 35° modules are connected to 20° modules were not taken into account, so the difference in annual energy yield compared to the StecaGrid 2000+ inverters will be even higher.

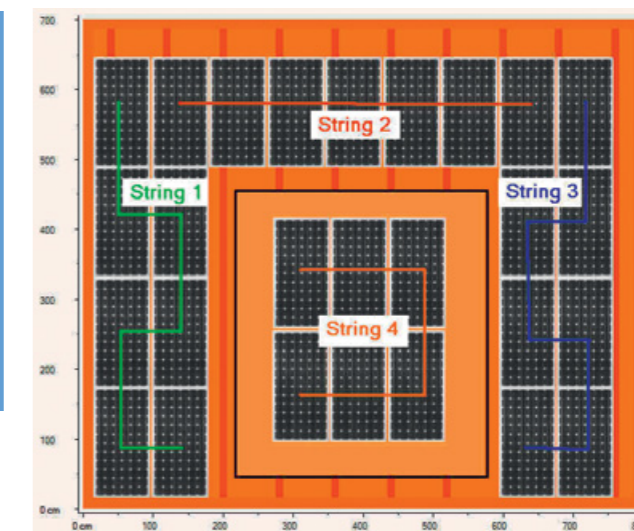

String connection of the 27 modules on the StecaGrid 2000+ inverters.



StecaGrid 2000+ and StecaGrid 2010+

2,000 W up to several 10,000 W

This product range consists of masters and slaves. Like the slaves, the master includes an inverter, but it also provides additional functions: a four-line display, a data logger for storing the yield values, country-specific grid monitoring of the alternating current output, and optional use of an interface card.

Flexible system design

Every inverter (Master or Slave) of the product range has two inputs, with each input having its own MPP tracker. One module string can be connected to each input. If required, the inputs can also be connected in parallel.

The advantage of such a system is the low sensitivity to negative influences such as (e.g.) partial shadowing, functional faults, or the dropout of a string. The use of several decentralised master-slave combinations reduces the cost of DC cabling, and minimises electrical losses.

Galvanic isolation

The StecaGrid 2000+ and StecaGrid 2010+ inverters are equipped with a high-frequency transformer, and are thus galvanically isolated. This enables unrestricted use of thin-film modules. Nevertheless, high efficiency of up to 95 % is achieved.

Diverse application situations

StecaGrid inverters offer constant high-power capability over a wide range of ambient temperatures. This is supported by maintenance-free, natural convection via the large-dimension cooling fins. Since no fans are used, the inverters work in virtual silence. Thanks to the high degree of protection, StecaGrid inverters are also suitable for outdoor installation.

StecaGrid 2010+ with integrated DC circuit breaker

To reduce the installation time, the StecaGrid 2010+ inverter has an integrated DC circuit breaker. For safety reasons, the cable cover located above the DC connector can only be removed when the DC circuit breaker is switched off.



StecaGrid 2010+ Master not shown: StecaGrid 2000+ Master
StecaGrid 2010+ Slave not shown: StecaGrid 2000+ Slave

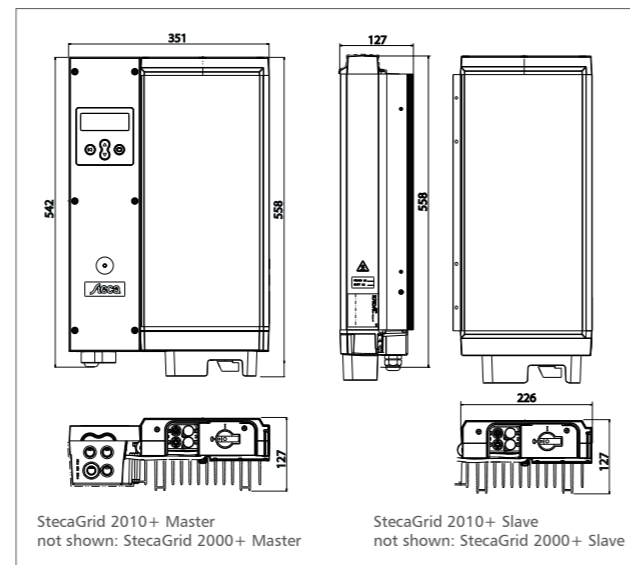

StecaGrid 2000+ and StecaGrid 2010+ (Master and Slaves) can be combined with each other.

Product features

- Two Maximum Power Point Trackers (MPP tracker) per device
- Flexible and expandable
- High efficiency
- Low weight
- Simple installation
- Master-slave concept
- Integrated DC circuit breaker (StecaGrid 2010+)
- Suitable for outdoor installation
- Fanless and maintenance-free
- Integrated data logger
- Wall-mounting with steel wall bracket for very easy installation

Displays

- Text LCD display
- for current output, energy yields, operating parameters, date, time, service information
- Multi-coloured LED shows operating states

Operation

- Multilingual menu navigation
- Four cursor buttons for menu selection

Data logger and Display System monitoring for StecaGrid 2000+ and StecaGrid 2010+

As standard, these inverters provide functions which enable complete integrated monitoring of the solar power system. The system's operating status (voltage, module output, grid frequency and grid voltage) and the energy yields of master and slaves are included. These measured values are shown on the display at all times.



System monitoring and accessories



DC circuit breaker (Page 52)



StecaGrid Connect Network interface card (Page 45)



StecaGrid Connect User software (Page 45)

	StecaGrid 2000+ D Master	StecaGrid 2000+ Master	StecaGrid 2000+ Slave	StecaGrid 2010+ D Master	StecaGrid 2010+ Master	StecaGrid 2010+ Slave
DC input side (PV-generator)						
Maximum start voltage	410 V					
Maximum input voltage	450 V (higher voltages can damage the device)					
Minimum input voltage	80 V					
Minimum input voltage for rated output	132 V					
MPP voltage	80 V ... 400 V					
Maximum input current	2 x 8 A (current limited by inverter) or 1 x 16 A (parallel inputs)					
Maximum input power at maximum active power	1,075 W (per input) or 2,150 W (2 parallel inputs)					
Maximum recommended PV power	2,400 Wp					
Grounding	- internal function grounding of the negative input for connecting amorphous and micromorphic thin-film modules					
AC output side (Grid connection)						
Grid voltage	190 V ... 265 V (depending on regional settings)					
Rated grid voltage	230 V					
Maximum output current	10 A					
Maximum active power (cos phi = 1)	2,000 W					
Rated power	2,000 W					
Rated frequency	50 Hz, optional 60 Hz			50 Hz		
Frequency	47.5 Hz ... 52 Hz (depending on regional settings)					
Night-time power loss	1.3 W	1.0 W	0 W	1.3 W	1.0 W	0 W
Feeding phases	single-phase					
Distortion factor (cos phi = 1)	< 5 % (max. power)					
Power factor cos phi	1					
Characterisation of the operating performance						
Maximum efficiency	95 %					
European efficiency	93.3 %		93.5 %		93.3 %	
MPP efficiency	> 99 %					
Power derating at full power	from 40 °C (T _{amb})					
Standby power	3 W					
Safety						
Isolation principle	HF-transformer with galvanic separation and amplified isolation					
Grid monitoring	yes, integrated		via Master		yes, integrated	
Selectable parameter settings	Netherlands, Belgium, France, Spain, Great Britain (Type with 60 Hz: DOM-TOM, Costa Rica)		via Master		Netherlands, Belgium, France, Spain, Great Britain	
Operating conditions						
Area of application	indoor rooms with or without air conditioning, outdoors with or without protection					
Ambient temperature	-25 °C ... +60 °C					
Relative humidity	0 % ... 95 %					
Noise emission	< 32 dBA					
Fitting and construction						
Degree of protection	IP 65					
Overvoltage category	III (AC), II (DC)					
DC Input side connection	MultiContact MC 4					
AC output side connection	WAGO terminal		via Master		WAGO terminal	
Dimensions (X x Y x Z)	351 x 542 x 140* mm		226 x 535 x 140* mm		351 x 558 x 140* mm	
Weight	approx. 11 kg		approx. 9 kg		approx. 11 kg	
Communication interface	optional StecaGrid Connect with Ethernet interface					
Integrated DC circuit breaker	no			yes		
Cooling principle	natural convection					
Test certificate	certificate of compliance as per DIN VDE 0126-1-1, CE mark, DK 5940, G83		CE mark, DK 5940, G83		certificate of compliance as per DIN VDE 0126-1-1, CE mark, DK 5940, G83	

*incl. mounting plate





WORLD RECORD

World record with coolcept

Steca has set a world record with its "coolcept" technology: A modified inverter reached 99.1 % peak efficiency! Based on EU benchmarks, the device achieved an average efficiency of 98.7 % over the entire power range.

„Coolcept“ was presented at the PV Symposium at Bad Staffelstein in March 2011. The tested device consists of a modified series product to demonstrate the capability of the design.

Inverters with coolcept:

StecaGrid 2020, 3000, 3600 and 4200

The high-end technology is implemented in the new inverter series of Steca at 2 kW, 3 kW, 3.6 kW and 4.2 kW nominal power. Peak efficiencies of 98.8 % are achieved.



StecaGrid 2020
StecaGrid 3000
StecaGrid 3600
StecaGrid 4200

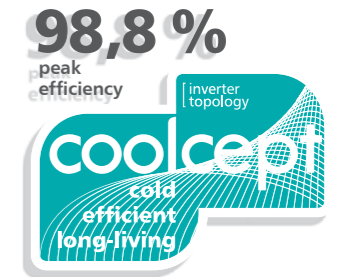

StecaGrid 2020 StecaGrid 3000 StecaGrid 3600 StecaGrid 4200

A world first: cool, long-living, efficient

What is "coolcept"?

"Coolcept" is Steca's new inverter topology that provides the highest peak efficiency. It is basically characterised by circuit simplicity combined with highest efficiency.

How does "coolcept" work?

The design uses symmetric step-down converters with downstream pole-reversing circuits. The separation into two different voltage levels allows the use of proven standard components.

The advantages of "coolcept":

"Coolcept" is cool. High peak efficiency means the lowest possible heat dissipation. This makes cooling elements unnecessary.

"Coolcept" is efficient. Stable peak efficiency over the entire power range ensures maximum yields.

"Coolcept" is long-living. Low heat dissipation and cool components guarantee a long service life.

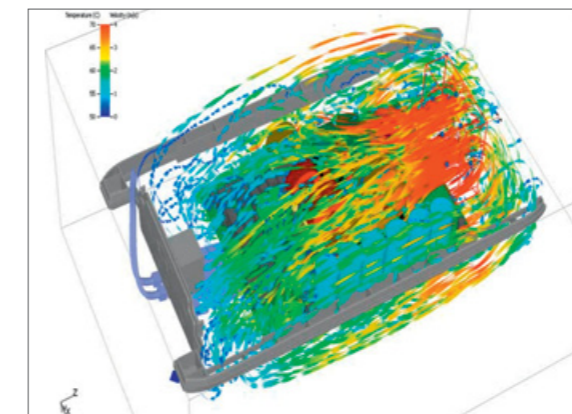
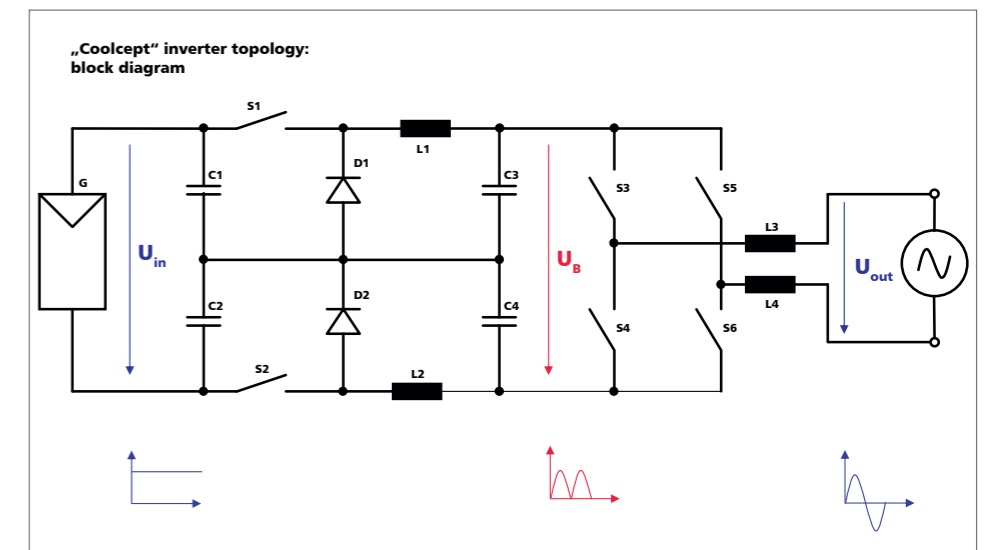

Innovative „coolcept“ inverter topology:
2 step-down converters with downstream pole-reversing circuits

StecaGrid 2020
StecaGrid 3000
StecaGrid 3600
StecaGrid 4200



Independent tests confirm highest level of efficiency

Photon Profi spoke of a „revolutionary“ new development. „Thanks to its innovative topology the StecaGrid 3600 can rightly call itself the champion of all classes. Until now, no inverter in series production has provided better results on the Photon test bench,“ was the summary on the new number one.

The AIT (Austrian Institute of Technology) in Vienna has confirmed that the StecaGrid 3600 achieves the highest efficiency. This has been verified by a comprehensive test report from the renowned institute.

Highest efficiency at all input voltages

The peak efficiency is only very slightly dependent on the module input voltage. This allows a free choice of the number and type of modules, without risking a loss of yields.

A completely new cooling concept

This is only possible through the top efficiency of the StecaGrid 3000 and StecaGrid 3600 inverters! The requirements – low-cost and high-efficiency – are fully satisfied!

StecaGrid 3000 and StecaGrid 3600 – the market lightweights



Production line – factory in Memmingen, Germany

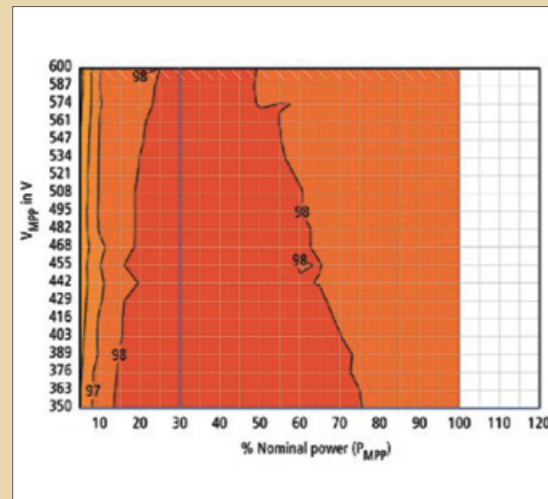

Conversion efficiency (Photon Profi 12/2011)

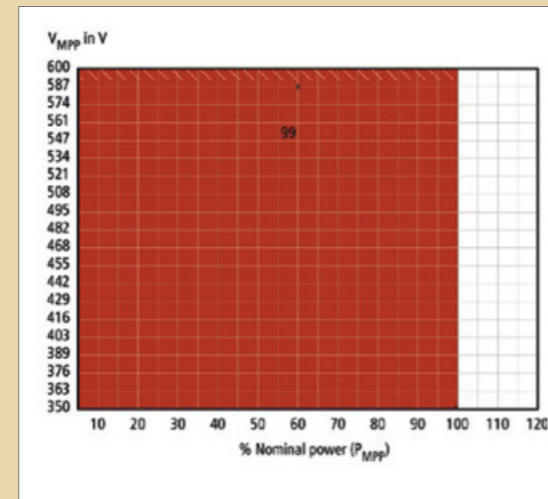

MPP efficiency: Highest MPP efficiency over the entire input range (Photon Profi 12/2011)



Test report from the AIT (Austrian Institute of Technology) in Vienna and Photon test label



StecaGrid 3000 and StecaGrid 3600 can be used in many different countries, which simplifies the warehouse logistics process.

StecaGrid 2020, StecaGrid 3000, StecaGrid 3600 and StecaGrid 4200

Inverter topology

The new „coolcept“ inverter topology, with an innovative circuit design that achieves highest efficiency, has now been integrated into these StecaGrid inverters.

The „coolcept“ inverter topology is based on a single-stage transformerless switching concept that uses proven standard components to implement symmetric step-down converters with downstream pole-reversing circuits.

Highest efficiency with longer service life

The high efficiency results in a peak efficiency of 98.8 % and a European efficiency of up to 98.3 %, which results in less lost power that must be dissipated into the environment. This improves your yields.

The efficiencies of these inverters are only very slightly dependent on the module input voltage. This allows the number and type of modules to be freely selected without resulting in a yield loss.

In addition to this, a new and unique cooling concept inside the inverter ensures an even distribution of the dissipated heat and a long service life for the device.

Product design and visualisation

For the first time, the very high efficiency allows the use of a design housing made of plastic. This offers many advantages, for example in the installation. The overall surface temperature of the StecaGrid remains very low. The inverters have protection class II.

The StecaGrid has a graphical LCD display for visualising the energy yield values, current performance and operating parameters of the system. Its innovative menu allows individual selection of the various measurements.

The guided, pre-programmed menu allows easy final commissioning of the device.

Product features

- Highest efficiency
- Simple installation
- Integrated data logger
- Firmware update possible
- Low housing temperature at full load
- Functionally perfect, environmentally-friendly plastic housing
- Lowest possible own consumption
- Integrated DC circuit breaker
- Protective insulation according to protection class II
- Very long service life
- Droop Mode for integration in hybrid systems (further information: Catalogue Steca PV Off Grid / Single-phase and three-phase AC hybrid systems)
- Fixed voltage mode for other energy sources
- Service menu for parameter adjustment
- 7-year warranty after registration

Displays

- Multifunction graphical LCD display with backlighting
- Animated representation of yield

Operation

- Simple menu-driven operation
- Multilingual menu navigation

Options

- System monitoring with Solar-Log™ and WEB'log
- Can be connected to the StecaGrid Vision display unit or a large-format display



Installation

The lightweights weigh only 9 kg and can be easily and safely mounted on a wall. The supplied wall bracket and practical recessed grips for right and left handed installers make mounting of the device simple and convenient. The device does not need to be opened for installation. All connections and the DC circuit breaker are externally accessible.

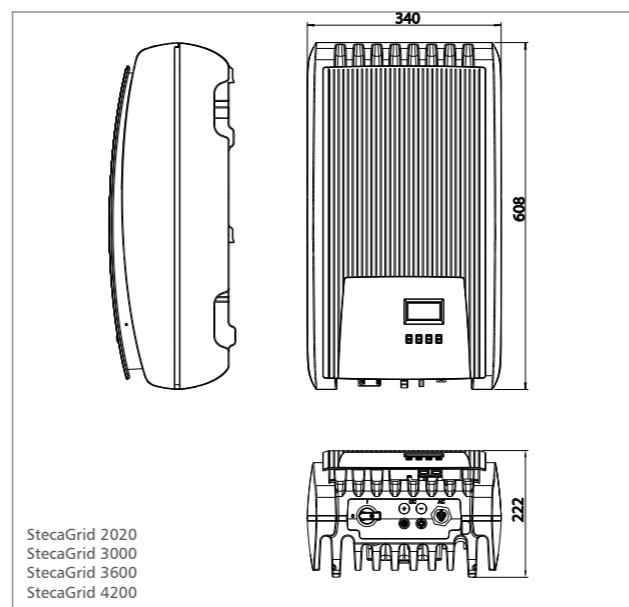

System monitoring and accessories

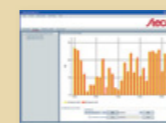

StecaGrid User
Visualisation software
(Page 46)



StecaGrid Vision
Display unit
(Page 47)



Meteocontrol WEB'log and Meteocontrol WEB'log Comfort
Data logger
(Page 50 and 51)



Solar-Log 500/1000™
Data logger
(Page 48)

	125 V AC StecaGrid 2020	StecaGrid 3000	StecaGrid 3600	StecaGrid 4200
DC input side (PV-generator)				
Maximum start voltage	450 V		845 V	
Maximum input voltage	450 V		845 V	
Minimum input voltage	190 V		350 V	
Minimum input voltage for rated output	210 V	350 V	365 V	430 V
MPP voltage	190 V ... 400 V		350 V ... 700 V	
Maximum input current		10 A		
Maximum input power at maximum active power	2,090 W	3,060 W	3,690 W	4,290 W
Maximum recommended PV power	2,400 Wp	3,800 Wp	4,500 Wp	5,300 Wp
AC output side (Grid connection)				
Grid voltage	90 V ... 150 V (depending on regional settings)	185 V ... 276 V (depending on regional settings)		
Rated grid voltage	125 V	230 V		
Maximum output current	18 A	16 A		19 A
Maximum active power (cos phi = 1)	2,000 W	3,000 W	3,600 W ¹⁾	4,200 W
Maximum active power (cos phi = 0.95)	-	3,000 W	3,530 W	3,990 W
Maximum apparent power (cos phi = 0.95)	-	3,130 VA	3,680 VA	4,200 VA
Rated power	2,000 W	3,000 W	3,600 W ²⁾	4,200 W ³⁾
Rated frequency	50 Hz and 60 Hz			
Frequency	45 Hz ... 65 Hz (depending on regional settings)			
Night-time power loss	< 0.9 W			
Feeding phases	single-phase			
Distortion factor (cos phi = 1)	< 2 %			
Power factor cos phi	> 0.99	0.95 capacitive ... 0.95 inductive		
Characterisation of the operating performance				
Maximum efficiency	97.5 %	98.6 %		98.8 %
European efficiency	96.7 %	98.2 %	98.1 %	98.3 %
Californian efficiency	96.8 %	98.3 %	98.2 %	98.4 %
MPP efficiency	> 99.7 % (static), > 99 % (dynamic)			
Own consumption	< 8 W			
Power derating at full power	from 50 °C (T _{amb})		from 45 °C (T _{amb})	
Standby power	6 W			
Safety				
Isolation principle	no galvanic isolation, transformerless			
Grid monitoring	yes, integrated			
Residual current monitoring	yes, integrated ⁴⁾			
Operating conditions				
Area of application	indoor rooms with or without air conditioning			
Ambient temperature	-15 °C ... +60 °C			
Storage temperature	-30 °C ... +80 °C			
Relative humidity	0 % ... 95 %, non-condensating			
Noise emission	< 39 dBA			
Fitting and construction				
Degree of protection	IP 21 (casing: IP 51; display: IP 21)			
Overvoltage category	III (AC), II (DC)			
DC Input side connection	MultiContact MC 4 (1 paar)			
AC output side connection	Wieland RST25i3 plug, mating connector included			
Dimensions (X x Y x Z)	340 x 608 x 222 mm			
Weight	9 kg			
Communication interface	RS485; 2 x RJ45 sockets; connectable to StecaGrid Vision, Meteocontrol WEB'log or Solar-Log™			
Integrated DC circuit breaker	yes, compliant with VDE 0100-712			
Cooling principle	temperature-controlled fan, variable speed			
Test certificate	CE mark	certificate of compliance as per DIN VDE 0126-1-1, CE mark, VDE AR N 4105, DK 5940, G83, UTE C 15-712-1, AS4777, CEI 0-21		

¹⁾ Belgium: 3,330 W ²⁾ Portugal: 3,450 W ³⁾ Portugal: 3,680 W ⁴⁾ The design of the inverter prevents it from causing DC leakage current.





StecaGrid 8000+ 3ph
StecaGrid 10000+ 3ph

StecaGrid 8000 3ph
StecaGrid 10000 3ph

Always symmetrical

For larger solar power systems, StecaGrid 8000+ 3ph, StecaGrid 10000+ 3ph, StecaGrid 8000 3ph and StecaGrid 10000 3ph are the ideal devices. They enable the creation of systems from 8 kWp to several MWp. These inverters are primarily used in systems on industrial roofs, agricultural buildings and in ground-mounted systems. Prerequisite: identical module orientation in each case, with no shadow problems.

323 kWp, roof-mounted installation, commissioning: 2008



Advantage of three-phase feeding

Power curve P (figure on the right-hand side) shows the power fed into the public electricity grid. The grey shaded area shows the energy to be stored in the inverter. With three-phase inverters, energy is fed into the grid on at least two phases at all times. Thus, the necessity of intermediate storage of energy in the device is greatly reduced, which is of benefit to the system operator with regard to a longer service life.

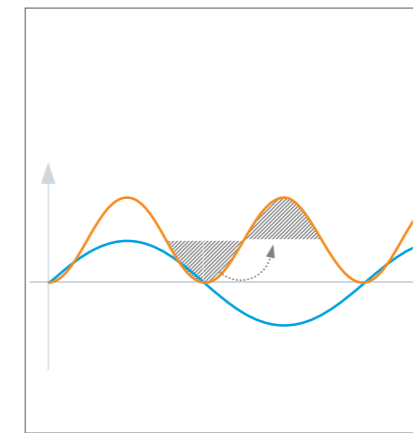

Single-phase feeding

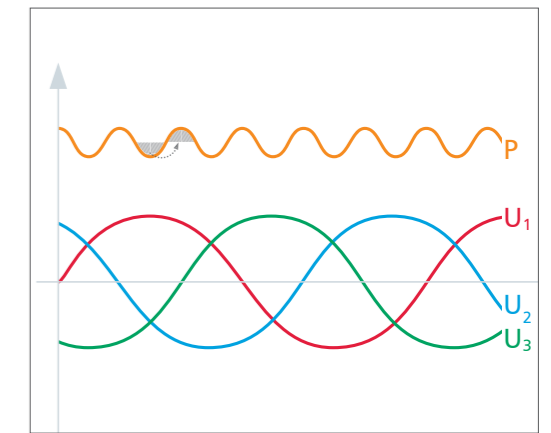

Three-phase feeding

Optimal choice for industry, agriculture and ground-mounted installations

The robust devices are optimally suited for outdoor installations. StecaGrid 8000 3ph and StecaGrid 10000 3ph inverters are currently providing good service in a large number of photovoltaic systems.

Display and operation

StecaGrid 8000+ 3ph and StecaGrid 10000+ 3ph have a graphical LCD display for visualising the energy yield values, current performance and operating parameters of the system. Its innovative menu allows individual selection of the various measurements.

The guided, pre-programmed menu allows easy final commissioning of the device.

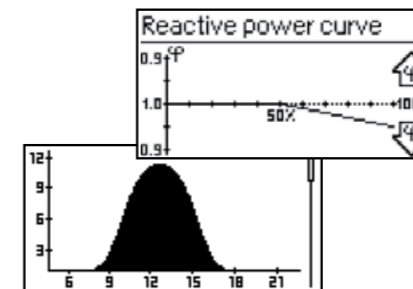

1MWp, ground-mounted installation, commissioning: 2011



265 kWp, ground-mounted installation, commissioning: 2010



StecaGrid 8000+ 3ph and StecaGrid 10 000+ 3ph

Always symmetrical

The advantage of three-phase feeding is that the produced solar capacity is always symmetrically distributed on all three power conductors to the public power grid. This is the case across the whole output range offered by these inverters. When designing a system, the laborious avoidance of an asymmetry of more than 4.6 kW through the appropriate selection of separate inverters is thus dispensed with. Symmetrical feeding is greatly in the interests of energy supply companies. Lengthy discussions with such companies are therefore a thing of the past.

Long service life

While the voltage passes through zero on the grid-feeding phase, single-phase inverters must temporarily accommodate all energy supplied by the solar modules within the device. This is usually realised by electrolytic capacitors. These components influence the service life of an electronic device, due to the possibility of drying out.

With three-phase inverters, energy is fed into the grid on at least two phases at all times. Thus, the necessity of intermediate storage of energy in the device is greatly reduced, which is of benefit to the system operator with regard to a longer service life.

Flexible connection

Due to the wide input voltage range of 350 V to 845 V, and a maximum input current of 27 A / 32 A, all commonly available crystalline solar modules can be connected to the inverters in various configurations. Beyond this, the system is also approved for use with CdTe and CIS / CIGS thin-film modules (www.stecasolar.com/matrix). Four plug/socket pairs are available for flexible, mechanical DC connection.

Product features

- High efficiency
- Wide input voltage range
- Three-phase, symmetrical grid feeding
- Integrated data logger
- Firmware update possible
- Integrated DC circuit breaker
- Robust metal casing
- Suitable for outdoor installation
- Wall-mounting with steel wall bracket for very easy installation

Displays

- Multifunction graphical LCD display with backlighting
- Animated representation of yield

Operation

- Simple menu-driven operation
- Multilingual menu navigation

Options

- System monitoring with Solar-Log™ and WEB'log
- Can be connected to the StecaGrid Vision display unit or a large-format display



StecaGrid 8000+ 3ph

StecaGrid 10000+ 3ph

Easy handling

The StecaGrid 8000+ 3ph and StecaGrid 10 000+ 3ph have a graphical LCD display for visualising the energy yield values, current performance and operating parameters of the system. Its innovative menu allows individual selection of the various measurements. The guided, pre-programmed menu allows easy final commissioning of the device.

Despite their high output, the inverters are wall-mounted devices. Thanks to the high degree of protection, these inverters can be installed indoors or outdoors. Due to the integrated DC circuit breaker, installation work is made easier, and the installation time is reduced. It is not necessary to open the inverter during installation.

Flexible system design

The combination of the StecaGrid 8000+ 3ph and the StecaGrid 10000+ 3ph allows optimum design for almost any power class. A diverse range of combinations are possible but they all share the same goal: the effective use of solar irradiation.

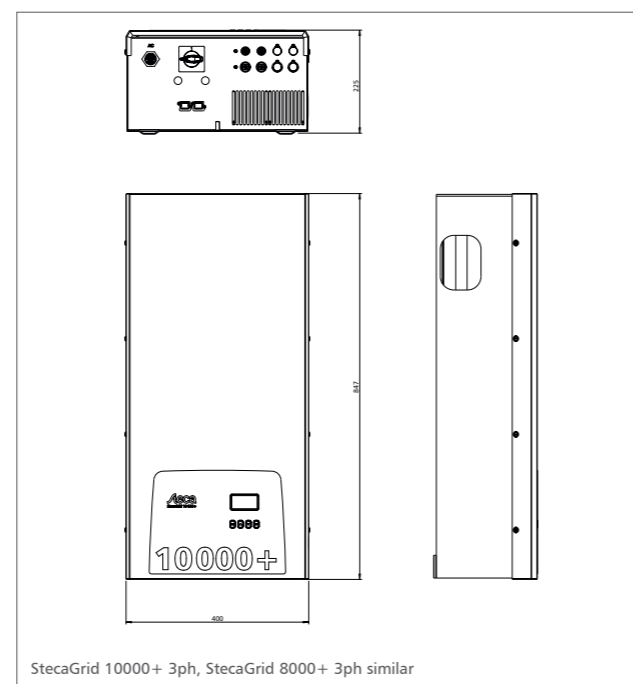

StecaGrid 10000+ 3ph, StecaGrid 8000+ 3ph similar

System monitoring and accessories



StecaGrid User Visualisation software (Page 46)



StecaGrid Vision Display unit (Page 47)



Meteocontrol WEB'log and Meteocontrol WEB'log Comfort Data logger (Page 50 and 51)



Solar-Log 500/1000™ Data logger (Page 48)

	8000+ 3ph	10 000+ 3ph
DC input side (PV-generator)		
Maximum start voltage	845 V	
Maximum input voltage	845 V	
Minimum input voltage	350 V	
Minimum input voltage for rated output	350 V	
MPP voltage	350 V ... 700 V	
Maximum input current	27 A	32 A
Maximum input power at maximum active power	9,250 W	10,800 W
Maximum recommended PV power	10,500 Wp	12,500 Wp
AC output side (Grid connection)		
Grid voltage	320 V ... 480 V (depending on regional settings)	
Rated grid voltage	400 V	
Maximum output current	16 A	
Maximum active power (cos phi = 1)	8,800 W ^{1) 3)}	10,300 W ^{2) 3)}
Maximum active power (cos phi = 0.95)	8,800 W ^{1) 3)}	9,800 W ³⁾
Maximum active power (cos phi = 0.9)	8,800 W ^{1) 3)}	9,300 W ³⁾
Maximum apparent power (cos phi = 0.95)	9,260 VA ⁴⁾	10,300 VA ⁴⁾
Maximum apparent power (cos phi = 0.9)	9,780 VA ⁴⁾	10,300 VA ⁴⁾
Rated power	8,000 W	9,900 W
Rated frequency	50 Hz	
Frequency	47.5 Hz ... 52 Hz (depending on regional settings)	
Night-time power loss	< 2.5 W	
Feeding phases	three-phase	
Distortion factor (cos phi = 1)	< 3 % (max. power)	
Power factor cos phi	0.9 capacitive ... 0.9 inductive	

	8000+ 3ph	10 000+ 3ph
Characterisation of the operating performance		
Maximum efficiency	96.3 %	
European efficiency	95.2 %	95.4 %
MPP efficiency	> 99 %	
Power derating at full power	from 50 °C (T _{amb})	
Standby power	9 W	
Safety		
Isolation principle	no galvanic isolation, transformerless	
Grid monitoring	yes, integrated	
Residual current monitoring	yes, integrated ⁵⁾	
Operating conditions		
Area of application	indoor rooms with or without air conditioning, outdoors with protection	
Ambient temperature	-20 °C ... +60 °C	
Storage temperature	-30 °C ... +80 °C	
Relative humidity	0 % ... 95 %, non-condensating	
Noise emission	< 60 dBA	
Fitting and construction		
Degree of protection	IP 54	
Overvoltage category	III (AC), II (DC)	
DC input side connection	Multicontact MC4 (4 pairs), rated current 22 A per input	
AC output side connection	Wieland RST25I5 plug, mating connector included	
Dimensions (X x Y x Z)	400 x 847 x 225 mm	
Weight	42 kg	
Communication interface	RS485; 2 x RJ45 sockets; connectable to StecaGrid Vision, Meteocontrol WEB'log or Solar-Log	
Integrated DC circuit breaker	yes, compliant with VDE 0100-712	
Cooling principle	temperature-controlled fan, variable speed	
Test certificate	certificate of compliance as per DIN VDE 0126-1-1, CE mark, VDE AR N 4105, G59, G83, AS4777, UTE C 15-712-1, CEI 0-21	

¹⁾ Germany and Denmark_unlimited: 8,000 W

²⁾ Germany and Denmark_unlimited: 9,900 W

³⁾ Denmark: 6,000 W

⁴⁾ Denmark: 6,670 VA at cos phi = 0.90; 6,320 VA at cos phi = 0.95

⁵⁾ The design of the inverter prevents it from causing DC leakage current



StecaGrid 8000 3ph and StecaGrid 10000 3ph

Always symmetrical

The advantage of three-phase feeding is that the produced solar capacity is always symmetrically distributed on all three power conductors to the public power grid. This is the case across the whole output range offered by these inverters. When designing a system, the laborious avoidance of an asymmetry of more than 4.6 kW through the appropriate selection of separate inverters is thus dispensed with. Symmetrical feeding is greatly in the interests of energy supply companies. Lengthy discussions with such companies are therefore a thing of the past.

Long service life

While the voltage passes through zero on the grid-feeding phase, single-phase inverters must temporarily accommodate all energy supplied by the solar modules within the device. This is usually realised by electrolytic capacitors. These components influence the service life of an electronic device, due to the possibility of drying out. With three-phase inverters, energy is fed into the grid on at least two phases at all times. Thus, the necessity of intermediate storage of energy in the device is greatly reduced, which is of benefit to the system operator with regard to a longer service life.

Flexible connection

Due to the wide input voltage range of 350 V to 845 V, and a maximum input current of 27 A / 32 A, all commonly available crystalline solar modules can be connected to the inverters in various configurations. Beyond this, the system is also approved for use with CdTe and CIS / CIGS thin-film modules. Five plug/socket pairs are available for flexible, mechanical DC connection.

Product features

- High efficiency
- Wide input voltage range
- Three-phase, symmetrical grid feeding
- Low DC discharge currents due to special switching concept
- Integrated DC circuit breaker
- Robust metal casing
- Suitable for outdoor installation
- Wall-mounting with steel wall bracket for very easy installation

Displays

- Multi-coloured LED shows operating states

Options

- System monitoring with Solar-Log™ and WEB'log
- Can be connected to the StecaGrid Vision display unit or a large-format display



StecaGrid 8000 3ph

StecaGrid 10000 3ph

Easy handling

Despite their high output, the inverters are wall-mounted devices. Thanks to the high degree of protection, those inverters can be installed indoors or outdoors. Due to the integrated DC circuit breaker, installation work is made easier, and the installation time is reduced. It is not necessary to open the inverter during installation.

Flexible system design

The combination of the StecaGrid 8000 3ph and the StecaGrid 10 000 3ph allows optimum design for almost any power class. A diverse range of combinations are possible but they all share the same goal: the effective use of solar irradiation.

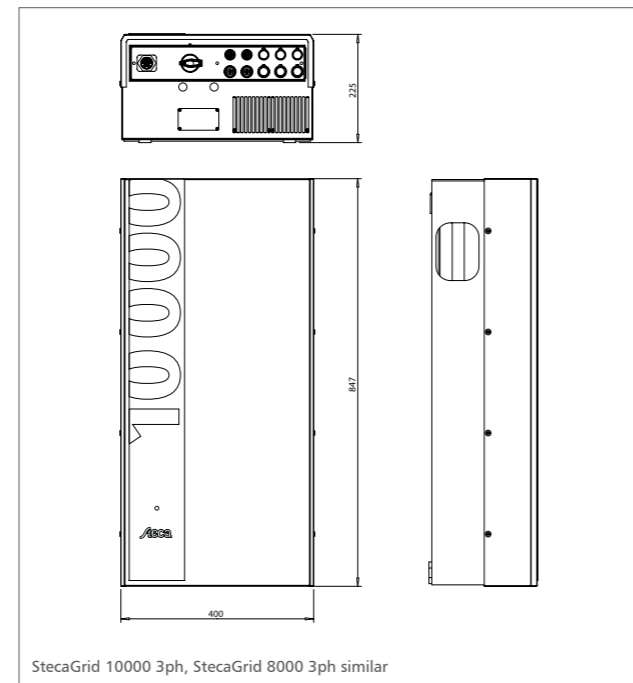

StecaGrid 10000 3ph, StecaGrid 8000 3ph similar

System monitoring and accessories

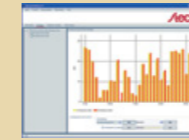

StecaGrid User Visualisation software (Page 46)



StecaGrid Vision Display unit (Page 47)



Meteocontrol WEB'log and Meteocontrol WEB'log Comfort Data logger (Page 50 and 51)



Solar-Log 500/1000™ Data logger (Page 48)

	8000 3ph	10 000 3ph
DC input side (PV-generator)		
Maximum start voltage	845 V	
Maximum input voltage	845 V	
Minimum input voltage	350 V	
Minimum input voltage for rated output	350 V	
MPP voltage	350 V ... 700 V	
Maximum input current	27 A	32 A
Maximum input power at maximum active power	9,250 W	10,800 W
Maximum recommended PV power	10,500 Wp	12,500 Wp
AC output side (Grid connection)		
Grid voltage	320 V ... 480 V (depending on regional settings)	
Rated grid voltage	400 V	
Maximum output current	15 A	
Maximum active power (cos phi = 1)	8,800 W	10,300 W ¹⁾
Rated power	8,000 W	9,500 W
Rated frequency	50 Hz	
Frequency	47.5 Hz ... 52 Hz (depending on regional settings)	
Night-time power loss	< 1.6 W	
Feeding phases	three-phase	
Distortion factor (cos phi = 1)	< 3 % (max. power)	
Power factor cos phi	1	
Characterisation of the operating performance		
Maximum efficiency	96.3 %	
European efficiency	95.2 %	95.4 %
MPP efficiency	> 99 %	
Power derating at full power	from 50 °C (T _{amb})	
Standby power	9 W	

	8000 3ph	10 000 3ph
Safety		
Isolation principle	no galvanic isolation, transformerless	
Grid monitoring	yes, integrated	
Residual current monitoring	yes, integrated ²⁾	
Operating conditions		
Area of application	indoor rooms with or without air conditioning, outdoors with protection	
Ambient temperature	-20 °C ... +60 °C	
Relative humidity	0 % ... 95 %	
Noise emission	< 60 dBA	
Fitting and construction		
Degree of protection	IP 54	
Overvoltage category	III (AC), II (DC)	
DC input side connection	Multicontact MC4 (5 pairs), Nennstrom 22 A je Eingang	
AC output side connection	Wieland RST2515 plug, mating connector included	
Dimensions (X x Y x Z)	400 x 847 x 225 mm	
Weight	42 kg	
Communication interface	RS485 plug-in card (included in delivery); 2 x RJ45 sockets; connectable to StecaGrid Vision, Meteocontrol WEB'log or Solar-Log	
Integrated DC circuit breaker	yes, compliant with VDE 0100-712	
Cooling principle	temperature-controlled fan, variable speed	
Test certificate	certificate of compliance as per DIN VDE 0126-1-1, CE mark, DK5940, G83, AS4777	

¹⁾ Belgium and Australia: 10,000 W

²⁾ The design of the inverter prevents it from causing DC leakage current



»PROFESSIONAL SYSTEM MONITORING FOR RELIABLE YIELDS«

Continuous system monitoring is recommended, or even essential, for obtaining the absolute maximum performance from your solar energy system at all times.



SYSTEM MONITORING AND ACCESSORIES

System monitoring



Accessories



Software





Displayed and analysed: Solar-Log™ WEB keeps you up-to-date on the optimum work of your system at all times – even on the road, with the Solar-Log™ App.

SYSTEM MONITORING











Locally and remotely

Continuous system monitoring is recommended, or even essential, for obtaining the absolute maximum performance from your solar energy system at all times. Steca offers you a number of different system monitoring methods:

Local monitoring is sufficient when the operator regularly checks the data on the display unit. Above and beyond this, the data logger monitors the functions of the system components, displays faults and stores all relevant system data.

Remote system monitoring is more convenient. The data logger can be connected to your PC and all system data can be displayed and analysed via the HTML user interface.

The most professional method is to use online monitoring. The data logger sends the system data to an external database. The operator can then log in to this database and not only analyse his or her data but can also compare the data with regional irradiance values. This thus provides the operator with an objective impression of the effectiveness of his or her PV system.

	StecaGrid 300 StecaGrid 500	StecaGrid 2000+ StecaGrid 2010+	StecaGrid 2020 StecaGrid 3000 StecaGrid 3600 StecaGrid 4200	StecaGrid 8000+ 3ph StecaGrid 10000+ 3ph StecaGrid 8000 3ph StecaGrid 10000 3ph
Local monitoring	 StecaGrid ALD1 Digital energy meter	 StecaGrid Connect User PC network interface with stored HTML pages	 StecaGrid User Visualisation software	 StecaGrid User Visualisation software
			 StecaGrid Vision Display unit	 StecaGrid Vision Display unit
Remote monitoring		 StecaGrid Connect User PC network interface with stored HTML pages	 Meteocontrol WEB'log Comfort Data logger and Meteocontrol Web'log web portal	 Meteocontrol WEB'log Comfort Data logger and Meteocontrol Web'log web portal
			 Solar-Log 500/1000™ Data logger and Solar-Log™ Web HTML user interface	 Solar-Log 500/1000™ Data logger and Solar-Log™ Web HTML user interface

Monitoring protects your yields:

Examples of faults and their effects:

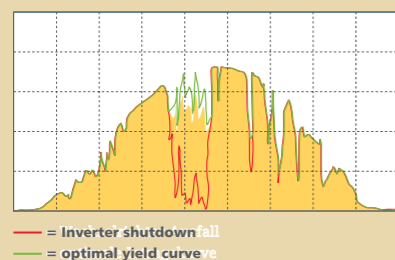
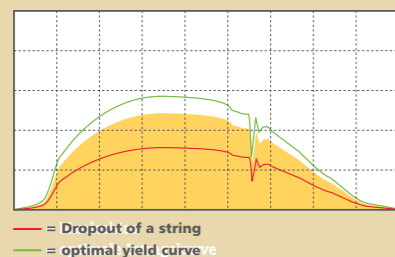

StecaGrid Connect User interface:

PV system yields based on a minute, day, month or annual profile

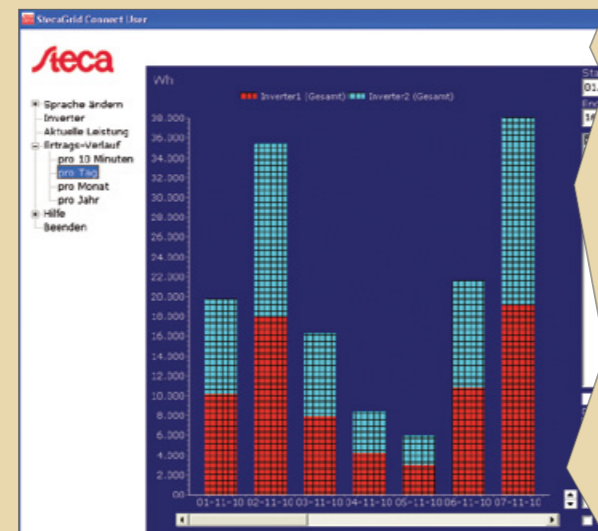

Ufe ENS26NA and Ufe ENS31NA Grid and system monitoring

The ENS26NA (designed for StecaGrid 300 and StecaGrid 500) is a single-phase GS protection with integrated 25 A relays according to VDE-AR-N 4105 with the respective declaration of conformity and tested functional safety. The device has a test key and an LCD display showing trigger values, current measurements, status and the last 9 grid errors and can either be employed as GS protection pursuant to VDE-AR-N 4105 or as replacement for the permanently accessible disconnection point according to DIN VDE 0126-1-1. Due to its islanding detection function, any supplier can be used even if they have no islanding detection properties of their own. Thanks to the built-in 25 A relays, no further contactors are required. The ENS-26NA is the perfect grid monitoring device for single-phase systems up to 5.7 kW.

The ENS31NA (designed for StecaGrid 8000+ 3ph, StecaGrid 10000+ 3ph, StecaGrid 8000 3ph and StecaGrid 10000 3ph) is a central GS protection for section switches according to VDE-AR-N 4105 with the respective confirmation of conformity for controlling two contactors or motor switches with feedback contact and tested functional safety. The device has a test key and an LCD display showing trigger values, current measurements, status, parametrization menu and the last 5 grid errors and can either be employed as central GS protection according to VDE-AR-N 4105 or as replacement for the permanently accessible disconnection point according to DIN VDE 0126-1-1.

The ENS26NA and ENS31NA automatic isolation units continually monitor the following parameters of the public electricity supply

- Overvoltage and undervoltage
- Frequency deviation
- Impedance jumps

In the event of faults in the mains supply, the ENS26NA resp. ENS31NA interrupts the feeding of electricity in the mains to prevent island effects.

The safety functions are executed in a dual channel system, whereby each channel monitors the proper function of the other channel. In case of a failure the channels disconnect independently from each other. The channels monitor each other mutually to increase error protection.

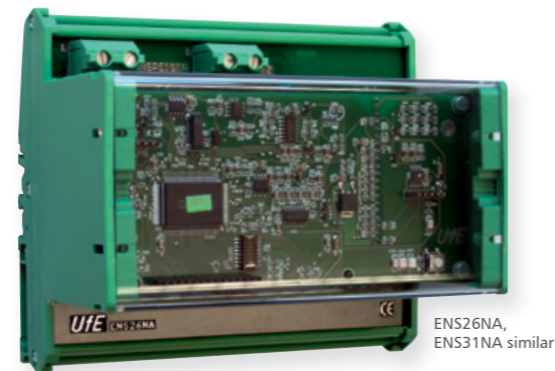

ENS26NA, ENS31NA similar

	ENS26NA	ENS31NA
AC output side (Grid connection)		
Rated grid voltage	230 V	3 x 230 V
Rated frequency	50 Hz	
Characterisation of the operating performance		
Switched power	< 5,750 W	depends on the allocated switches
Rated current of power feeder	25 A	depends on the switched output of the switches
Own consumption	1.5 W	3.5 W
Safety		
Grid monitoring	compliant with DIN VDE 0126-1-1	
Overvoltage (fast shutdown)	> 300 V (response time 0.02 s)	
Overvoltage	> 264 V (response time 0.2 s)	
Overvoltage	230 V +10 % over 10 min.	
Undervoltage	< 184 V (response time 0.2 s)	
Frequency deviation	+1.5 Hz / -2.5 Hz (response time 0.2 s)	+1.5 Hz / -2.5 Hz (response time 0.1 s)
Impedance jump and islanding detection	> 0.5 Ohm (response time 5 s)	
Operating conditions		
Ambient temperature	-20 °C ... +40 °C	
Relative humidity	10 % ... 90 %, non-condensating	
Fitting and construction		
Dimensions (X x Y x Z)	146 x 111 x 80 mm	220 x 111 x 80 mm
Test certificate	certificate of compliance as per DIN VDE 0126-1-1, CE-Zeichen, VDE AR N 4105	

StecaGrid ALD1 Digital energy meter

System monitoring for StecaGrid 300 and StecaGrid 500



- #### Product features
- Wall-mounting with top-hat rail

- #### Displays
- LCD display with backlight, digits 5 mm high for current output, energy yields, voltage and current

- #### Operation
- via button

	StecaGrid ALD1
AC output side (Grid connection)	
Rated grid voltage	230 V (-20 % / +15 %)
Rated frequency	50 Hz
Rated current	5 A
Measurement current	32 A
Characterisation of the operating performance	
Accuracy class	1 (1 %) as per IEC 62 053-21 or B in accordance with EN 50 470-3 (devices in accordance with MID)
Operating conditions	
Ambient temperature	-10 °C ... +55 °C
Storage temperature	-30 °C ... +85 °C
Relative humidity	95 % at 25 °C ... 40 °C, non-condensating
Fitting and construction	
Terminal (fine / single wire)	primary circuit: max. 6 mm ² impulse output: max. 2.5 mm ²
Dimensions (X x Y x Z)	17.5 x 89.2 x 63.4 mm
SO output	optocoupler max. 30 V / 20 mA and min. 5 V, impedance 100 Ω, impulse range 50 ms, transmission distance max. 1,000 m (at 30 V / 20 mA)
Pulses per kWh	2,000 (LC display), 1,000 (SO output)
Test certificate	CE mark

StecaGrid Connect and software for system monitoring

PC network interface for StecaGrid 2000+ and StecaGrid 2010+

Monitoring with the optionally available StecaGrid Connect network card is convenient. Here, the integrated web server makes it possible to display data in a normal web browser (e.g. Internet Explorer) without additional software.

The free StecaGrid Connect User software offers additional possibilities for graphical analysis and archiving of data.

Your own PC is all you need in order to view and analyse all of the solar power system's data at your desk, conveniently presented with the aid of the software, in a graphically understandable format.

With StecaGrid Connect Service, the installer has the ideal tool with which to guarantee prompt, precise, and problem-free service.

Remote monitoring

If the inverter is also connected to the Internet, it is possible to monitor the solar energy system from any computer in the world via StecaGrid Connect. Password-protected access occurs with the StecaGrid Connect User/Service software, or simply via a normal web browser.

In addition, Steca offers the option of external system monitoring. Via e-mail, the user is not only informed of their inverters' yields, but also of any faults which arise.

Product features

- Integrated web server

Interfaces

- Ethernet interface

	StecaGrid Connect
Fitting and construction	
Dimensions (X x Y x Z)	128 x 62 x 20 mm
Weight	0.05 kg
Communication interface	Ethernet interface
Test certificate	CE mark

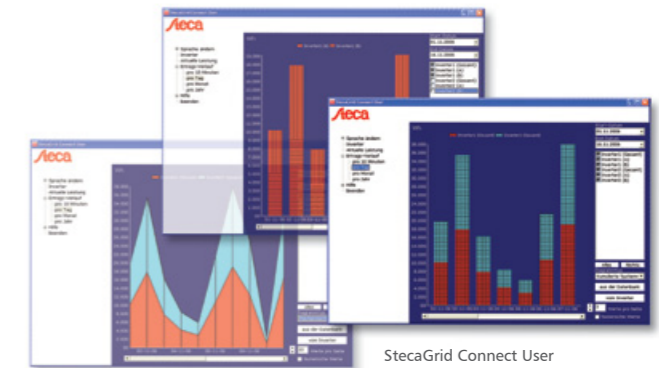

StecaGrid Connect User user interface

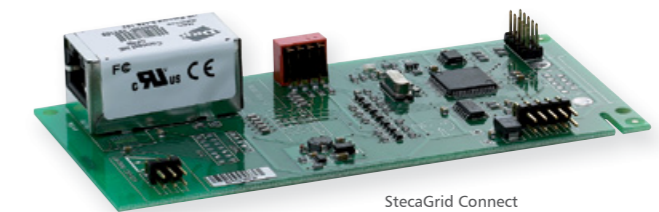

StecaGrid Connect network interface card



StecaGrid User

Visualisation software for StecaGrid 2020, 3000, 3600, 4200, 8000+ 3ph, 10000+ 3ph, 8000 3ph and 100000 3ph

Universal and individual

The StecaGrid User software allows system operators to transfer entries from inverter data loggers to a computer and subsequently analyse the data. Inverters store diurnal variation curves, among other data. After 31 days, the oldest data are overwritten with new data. Using the StecaGrid User software, data can be read regularly and stored permanently on a computer.

The StecaGrid User software allows users to read the data of up to 100 inverters via a bus and have the data arranged and presented in a graph. The programme provides a clear overview of diurnal, monthly and annual variation curves both for the entire system and for each individual inverter. Yield data of several inverters can thus be compared. Various presentation options and colour schemes ensure that comparisons are clearly laid out.

The StecaGrid User also presents current measurements on the computer screen. The data that can be called up individually on the inverter's display are clearly presented on one StecaGrid User page.

Prepared for the future!

Choosing the 'information' menu item, users can read the hardware and software status of the connected inverters. The StecaGrid User software also carries out updates when new, improved software is available or new technical requirements necessitate a software adaptation.

The yield data read from one inverter can be transferred to another inverter using the StecaGrid User software.

The software is available for free download at www.steca.com. The computer connection requires a RS485 USB adapter cable.

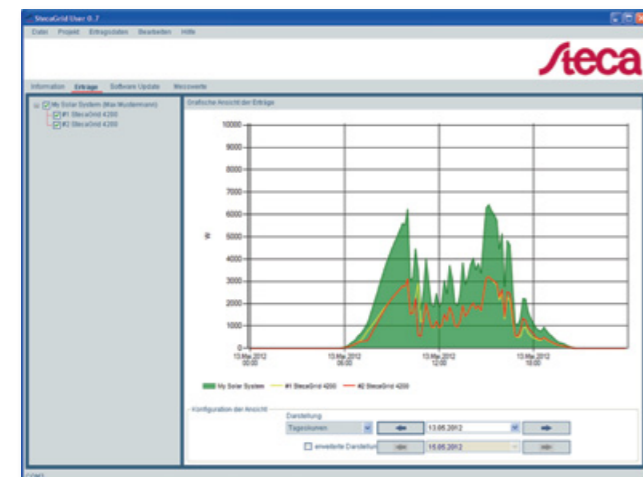

Diurnal, monthly and annual variation curves are clearly presented on one StecaGrid User page.

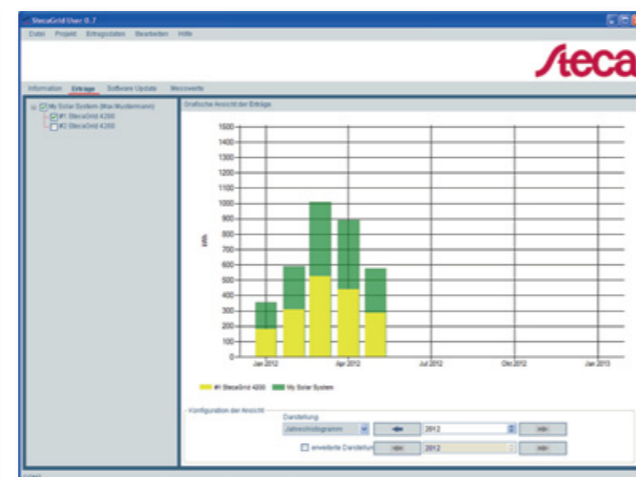

StecaGrid Vision

Display unit for StecaGrid 2020, 3000, 3600 and 4200, StecaGrid 8000+ 3ph and StecaGrid 10000+ 3ph, StecaGrid 8000 3ph and StecaGrid 10000 3ph

One photovoltaic system – one display

The philosophy behind the StecaGrid Vision display unit is to provide the system operator with a representation of the entire system's data. In the default display, the output and yields of all connected StecaGrid inverters are shown as combined totals. Thus, the operator does not need to go from one inverter to the next, reading out the values individually and adding them up themselves. Naturally, it is also possible to view and compare data from individual inverters.

Up to 20 inverters can be connected

One to 20 StecaGrid inverters can be connected to the optional StecaGrid Vision display unit. The wired connections between the inverters and to the display unit are realised via Steca's own communication bus.

Easy to operate

The StecaGrid Vision impresses with its design. It is operated by means of four modern capacitive buttons. Graphic curves show the energy yields from the system as a whole, and from individual inverters, thus providing information at a glance, regarding the performance over the course of the day. In addition, StecaGrid Vision has a data logging function, which also enables querying of historical data. Error messages regarding the system as a whole, as well as individual inverters, are shown in plain text.

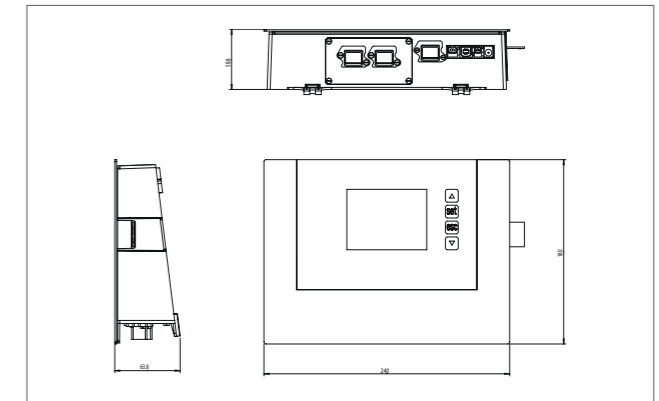

Product features

- Integrated data logger
- Self-test feature for Italy

Display

- Multifunction graphic LCD display with backlighting for current output, energy yields, operating parameters, date, time, service information
- Animated representation of yield

Operation

- Multilingual menu navigation

StecaGrid Vision	
Application conditions	
Area of application	indoor rooms, with or without air conditioning
Interface to inverter	Steca bus with max. 1,000 m cable length
Ambient temperature	-20 °C ... +45 °C
Humidity	0 % ... 95 %
Noise emissions in standard operating conditions	silent
Equipment and design	
Protection class	IP 20
Dimensions (X x Y x Z)	240 x 180 x 63.8 mm
Weight	450 g
Power supply	230 V mains adapter plug (included in delivery)
Communication interface	USB
Range	1,000 m
Test certificate	CE mark

Exemplary interconnection

StecaGrid 10000 3ph, StecaGrid 8000 3ph, StecaGrid 3000 and StecaGrid 3600 inverters with StecaGrid Vision display unit:



Solar-Log™ data logger

Professional remote monitoring

Data loggers by Solare Datensysteme are sought-after specialists for optimised remote monitoring of photovoltaics systems. The combination of StecaGrid inverters with Solar-Log™ now guarantees complete monitoring of your photovoltaic system: all operating parameters, status and error messages of the connected inverters can be viewed simply and reliably. That guarantees maximum yield from your system at all times.

Advantages

- Guaranteed yield via comprehensive system monitoring and a wide range of alarm options
- Web-based software – no need to install programmes
- Clear presentation of the yield and system values in graphs and tables
- View data via internet connection – anywhere, any time
- Optional recording, calculation and optimisation of electricity consumption
- Comprehensive range of accessories – provides many other functions



Solar-Log¹⁰⁰⁰

Solar-Log⁵⁰⁰



Solar-Log⁵⁰⁰ (up to 10 inverters)
 + StecaGrid 10000+ 3ph
 + StecaGrid 10000+ 3ph
 + StecaGrid 10000+ 3ph
 Solar-Log¹⁰⁰⁰ (up to 100 inverters)

Local monitoring via integrated display

The displays on Solar-Log 500™ and Solar-Log 1000™ show all relevant data of the photovoltaics system. Solar-Log 1000™ also offers an alarm output, to which a siren or alarm lamp can be connected.



All important information at a glance: Daily profile, current, daily and overall energy yield. Errors are signalled acoustically.

Remote monitoring via internet

The photovoltaics system can be monitored remotely for even greater convenience: For this function, Steca offers Solar-Log™ WEB on a separate server (www.stecalog.com). This provides you with access to all important yield values anywhere and at any time.



Displayed and analysed: Solar-Log™ WEB keeps you up-to-date on the optimum work of your system at all times – even on the road, with the Solar-Log™ App.

Solar-Log™ monitoring circuit

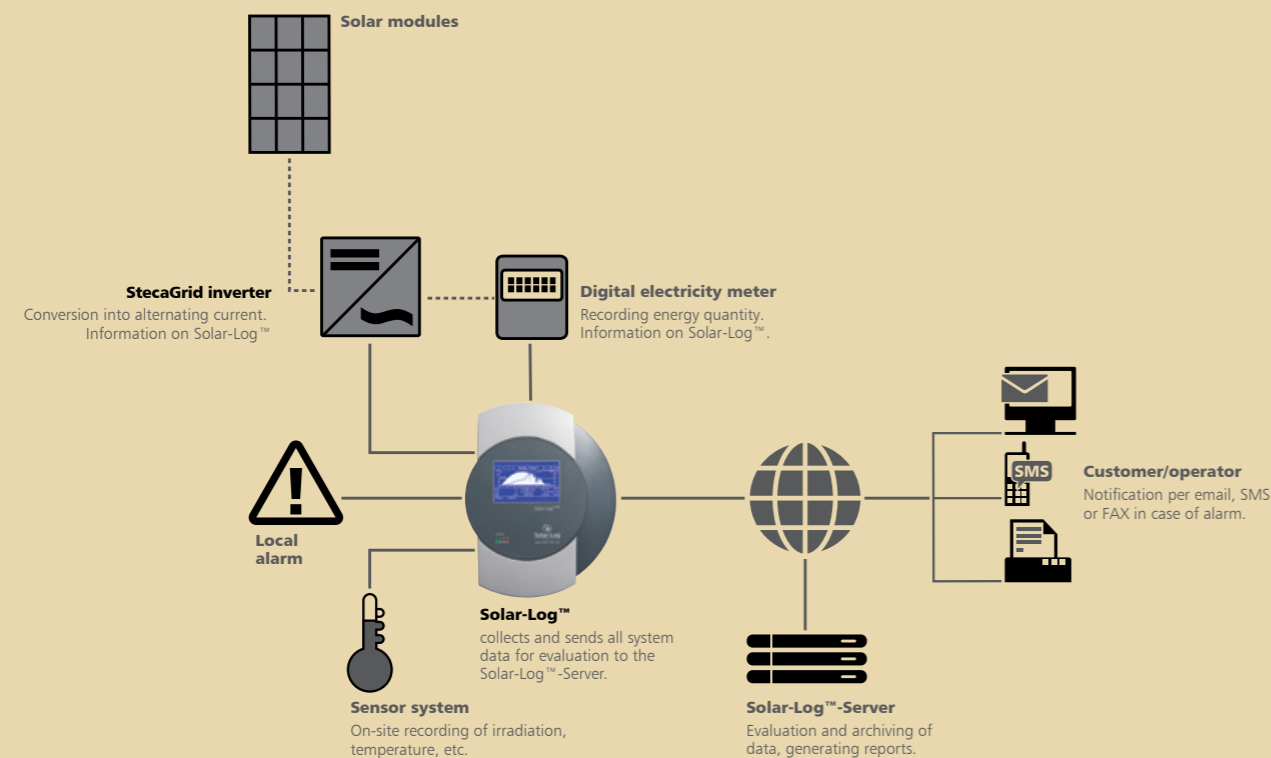

Monitoring guarantees your yield: Examples of faults and their consequences:

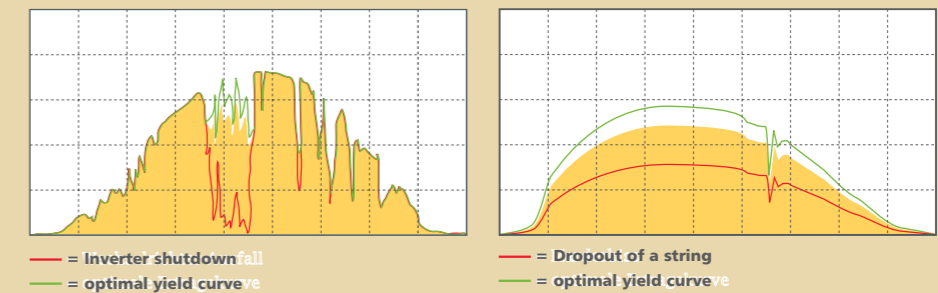

Installation, configuration and system management

Select the cost-effective basic service or convenient combined package:

Photovoltaic system setup
We set up your system on the Steca server. The server then informs you regularly via e-mail of the status and error messages of the photovoltaic system.

Photovoltaic system setup and monitoring
If you want us to take on all the work, our employees can monitor your system constantly after setup: if anything out of the ordinary occurs, we inform you personally and diagnose the error. That minimises system downtime and guarantees optimum yield! At the end of the day, that saves time and money!



Meteocontrol WEB'log for commercial systems

Professional remote monitoring

- Area of application**
- Remote monitoring of photovoltaic systems
- Product features**
- Solar management
 - Web portal in several languages
 - Convenient evaluation of measurement data
 - High-performance report generator
 - Target/actual comparison of energy yield
 - Online values
 - Safer'Sun info
 - Access to your system via your own homepage
 - Administration and allocation of guest access
 - You can integrate evaluations and diagrams in your website
 - Safer'Sun portal
 - The Safer'Sun portal can be adapted to your own corporate design
 - Custom-made to your wishes and requirements
- Advantages**
- Best energy yield
 - Innovative and intelligent technology
 - Maximum safety
 - Guaranteed pay-back!



Meteocontrol WEB'log Comfort Ultimate display comfort for private installations

Professional remote monitoring

- Area of application**
- Remote monitoring of photovoltaic systems
- Product features**
- Solar management
 - Free web portal in several languages
 - Convenient evaluation of measurement data
 - High-performance report generator
 - Target/actual comparison of energy yield
 - Online values
 - Safer'Sun info
 - Access to your system via your own homepage
 - Administration and allocation of guest access
 - You can integrate evaluations and diagrams in your website
 - Safer'Sun portal
 - The Safer'Sun portal can be adapted to your own corporate design
 - Custom-made to your wishes and requirements
- Advantages**
- Best energy yield
 - Innovative and intelligent technology
 - Maximum safety
 - Guaranteed pay-back!
 - Control of loads to increase the self consumption of generated pv-power



Functional principle of meteocontrol WEB'log

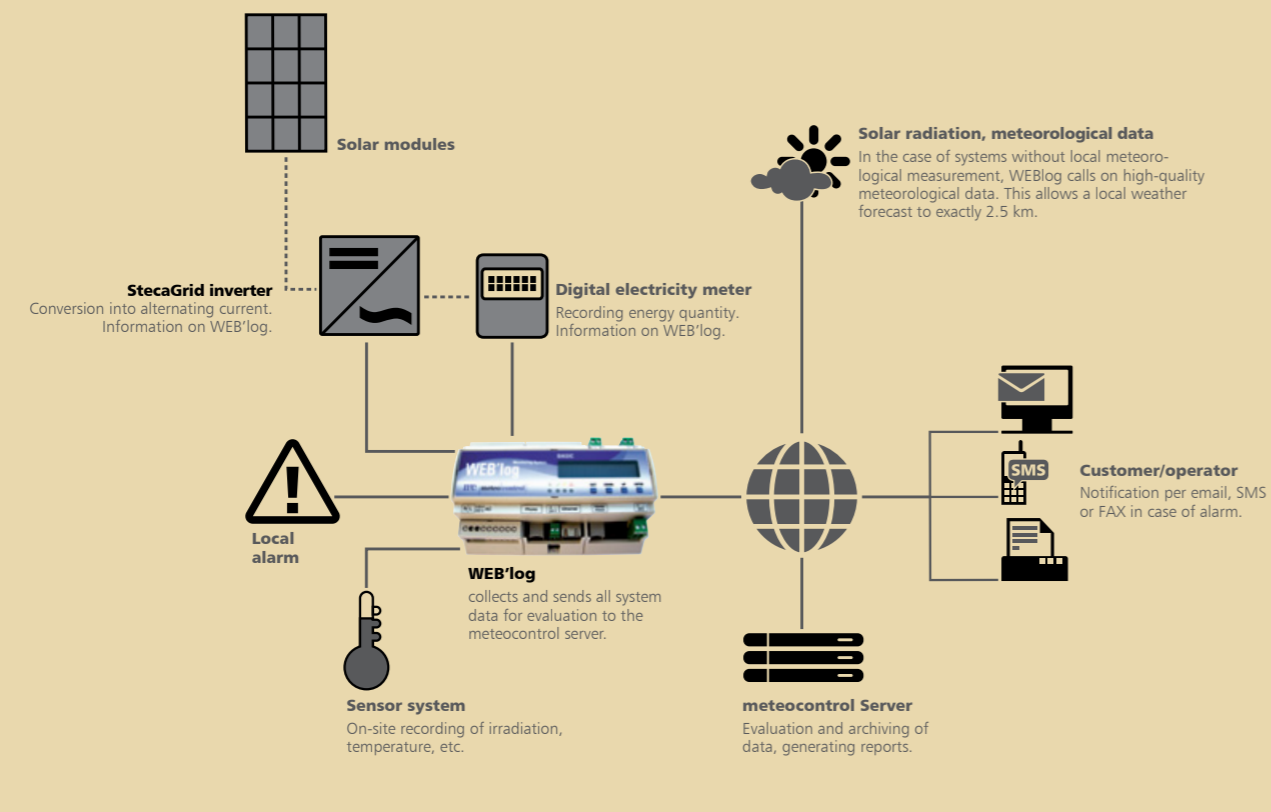

Functional principle of Meteocontrol WEB'log Comfort

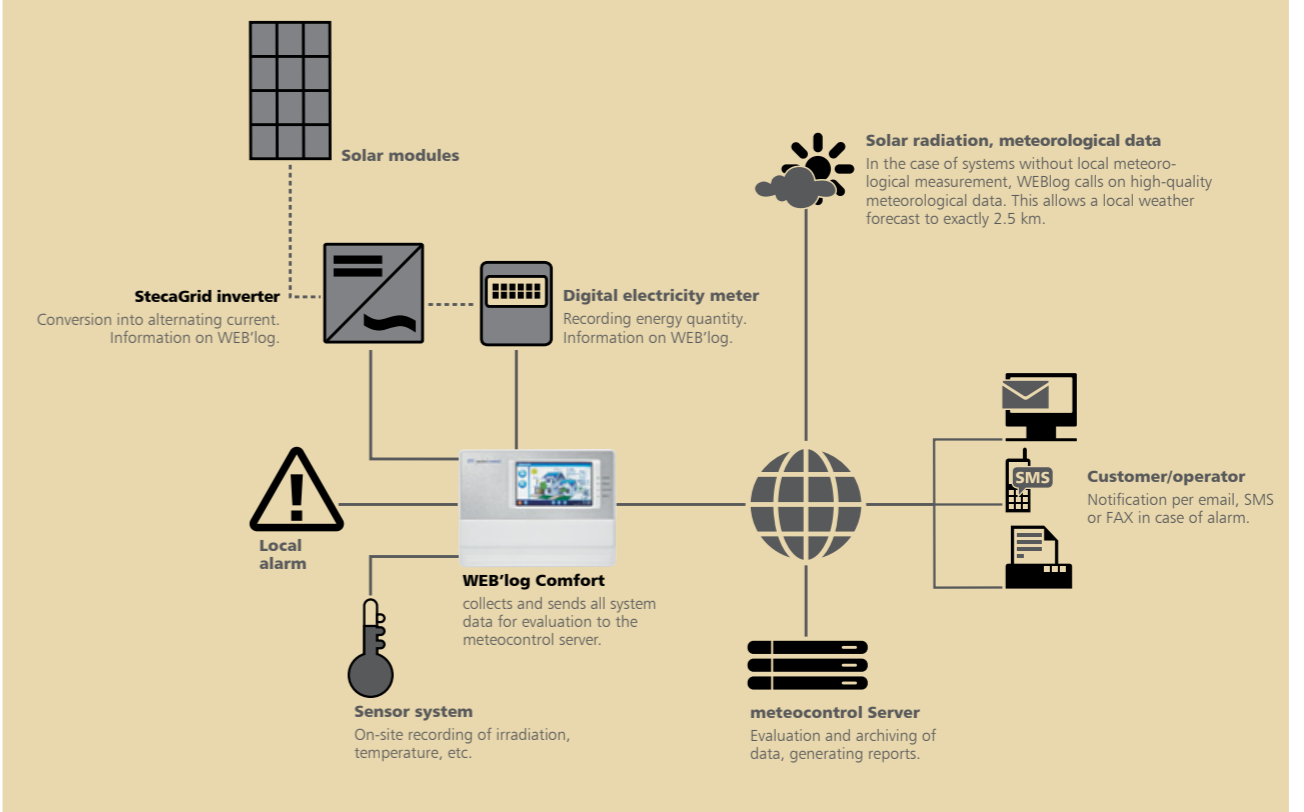

DC circuit breaker for StecaGrid 300 and StecaGrid 500

250 V DC, 6 A DC, 6-pole

One DC circuit breaker can be used for one to three inverters. If the inputs are single-phased, up to six inverters can be connected via one DC circuit breaker.

Certificates

- Compliant with DIN VDE 0100-712

DC circuit breaker for StecaGrid 300 and StecaGrid 500	
DC input side (PV-generator)	
Maximum input voltage	250 V
Maximum input current	6 A per contact
Operating conditions	
Area of application	indoor rooms, with or without air conditioning, outdoors with or without protection
Ambient temperature	-40 °C ... +60 °C
Relative humidity	0 % ... 95 %
Fitting and construction	
Degree of protection	IP 65
Terminal (fine / single wire)	10 mm ² / 16 mm ²
Dimensions (X x Y x Z)	125 x 200 x 122 mm
Weight	1.2 kg
Test certificate	CE mark



► Wiring information for the DC circuit breaker can be found on our website (www.steca.com).

DC circuit breaker for StecaGrid 2000+

450 V DC, 16 A DC, 2-pole, 4-pole and 6-pole

Steca offers suitable DC circuit breakers especially designed for these inverters. 2-pole, 4-pole and 6-pole circuit breakers are available.

Product features

- Compliant with DIN VDE 0100-712

DC circuit breaker	2-pole	4-pole	6-pole
Operating conditions			
Area of application	indoor rooms with or without air conditioning, outdoors with or without protection		
Ambient temperature	-20 °C ... +55 °C		
Relative humidity	0 % ... 95 %		
Fitting and construction			
Degree of protection	IP 66		
Terminal (fine / single wire)	10 mm ² / 16 mm ²		
Dimensions (X x Y x Z)	100 x 190 x 93 mm	145 x 250 x 107 mm	
Weight	0.6 kg	1 kg	
Test certificate	CE mark		



2-pole, 4-pole DC circuit breaker, 6-pole DC circuit breaker similar

► Wiring information for the DC circuit breaker can be found on our website (www.steca.com).

Rated values (PV-generator)			
Operational current	4.68 A	5.54 A	6.79 A
Operational voltage	450 V DC	380 V DC	310 V DC
Max. open circuit voltage	520 V DC		
Rated insulation voltage	690 V		
Operational current	8.77 A	12.38 A	26.32 A
Operational voltage	240 V DC	170 V DC	80 V DC
Max. open circuit voltage	520 V DC		
Rated insulation voltage	690 V		

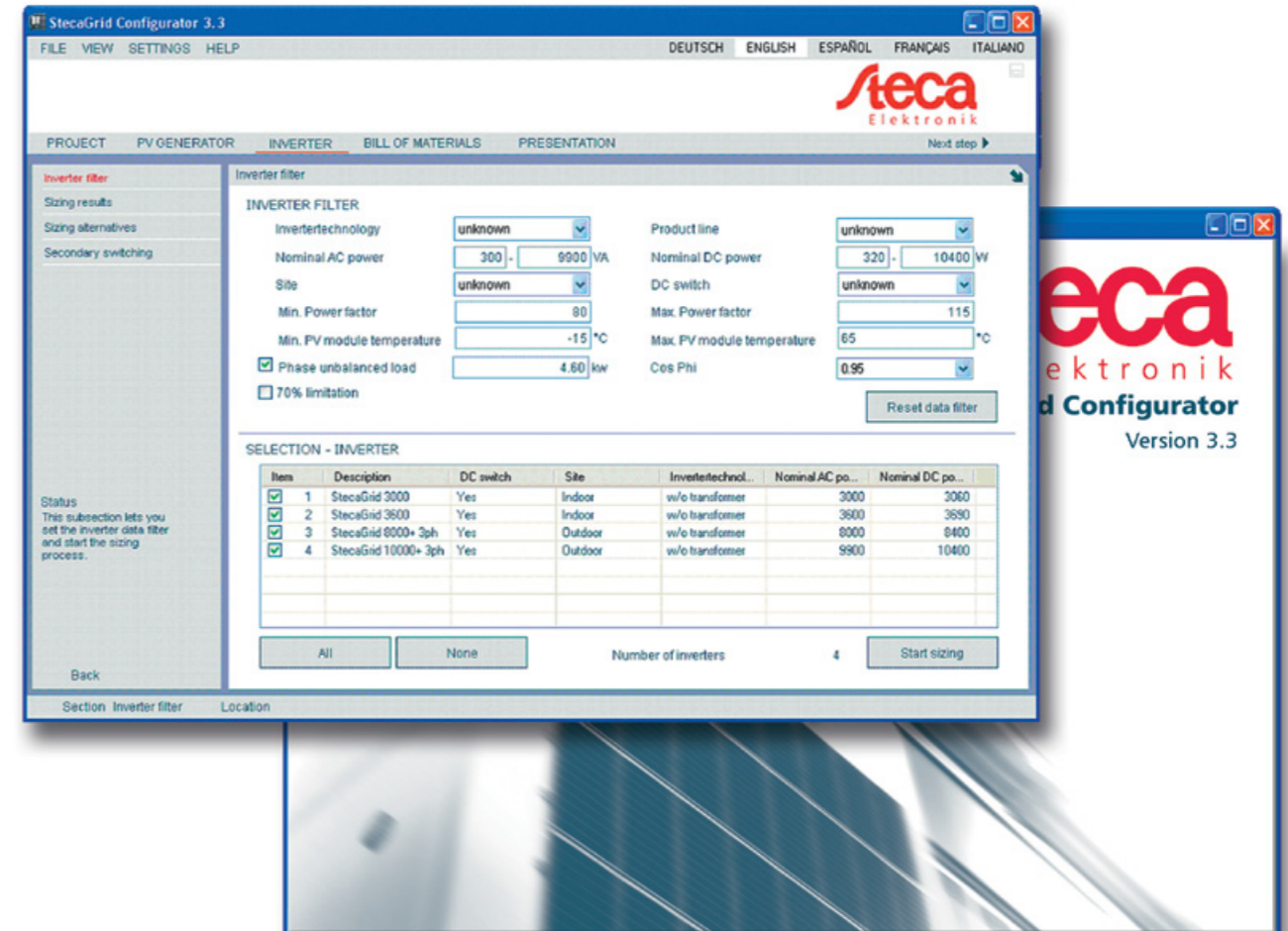

PROFESSIONAL SYSTEM MONITORING

with StecaGrid Configurator 3.3

The update version of the StecaGrid Configurator makes it possible to plan a photovoltaic system in an even more professional manner. It offers a wealth of improvements compared to its forerunner, the 3.2 version.

Among the new features is the inclusion of the new 70 percent rule for design relationships where the output power is only 70 percent of the module power. To consider the reactive power, Cos Phi (1.00; 0.95 or 0.90) can be selected. The system planner can also specify the maximum and minimum module temperatures. The number of modules to be used in the selected system configuration can be modified subsequently. The effects on the system values and yields as well as exceeding of the input parameters are clearly shown.

This version is self-contained, offering a convenient user interface. There are four different options for determining the size of a photovoltaic system after selecting a module type. In addition, modules stored in a large database can be filtered according to specific criteria. If the required module is not stored in the database, you can add own modules to the programme. This is followed by the selection of the inverters according to a range of specifications, for example the installation site and rated AC or DC power. The calculated cost of generating electricity is taken as the standard selection criterion. To help with

the specifications, the programme includes different values for the cost of systems planning as well as for modules, wiring, installation systems, etc. The installing company can provide their client data and company logo, which will appear on the printouts. A total of 100 locations throughout Europe offer irradiation data to help predict annual energy yield.

The predicted annual energy yield and the similarly editable values for the discount factor and operating time together allow the exact calculation in cents per kilowatt hour of the costs incurred by a system in producing electricity. On the basis of the electricity generation costs, it is possible to ascertain at a glance whether it would be more efficient to use the inverter with one more solar module, or one fewer. A list of required parts, the connection diagram and a summary of the project data all guarantee professional preparation for sales meetings with customers.

The programme's menu navigation can be set to German, English, French, Italian or Spanish.

The software is available free of charge at: www.steca.com

For updates please refer to the Steca web site.



»EXPERT SUPPORT«

Secure a knowledge advantage and additional competitive advantages by contacting us!



SERVICE





Production - factory in Memmingen, Germany



SUPPORT

with added value, exclusively for Steca Service Partners

Whether workshops, guarantee extensions or marketing tools: Whatever you need in our diverse range of Service Partner services, we support you with know-how and advertising material for your professional presence.

Seminars

Steca is offering seminars on all product-related topics as a workshop. Here, you will learn from the trainers how to use the products for your application, as well as their function, installation and operation. Your opinion counts in order to present better solutions.



Steca in figures	
Number of component groups produced per year	3.8 million
Number of component groups supplied daily	18,000
Number of component group types produced per year	3,000
Number of production orders continuously being processed	600
Number of components that are fitted onto printed circuit boards per hour	50,000
Number of components fitted per year on average	230 million
Number of employees in 1976	3
Number of employees in 2011	650

Production information relates to average orders and production capacities in 2010.

With the purchase of any Steca product you benefit from our extensive range of services:



Hotline/Support

Our capable customer advisers and technical support department are at your service at all times to answer any product questions you may have. +49 (0) 700 STECAGRID (+49 (0) 700 783224743) (Monday to Friday from 8⁰⁰ to 16⁰⁰; 12 Euro-cents/minute from within the German public telephone network) or outside business hours: service@stecasolar.com. Naturally, we support our international partners in their national language: we have customer advisers who speak English, French, Spanish or Italian.



Guarantee and guarantee extension

We provide a 5-year guarantee on all grid inverters. Within the first 2 years it is possible to extend the guarantee to 10 or 20 years. We offer our trading and service partners especially favourable commercial and legal guarantee conditions and cost-sharing flat-rates.



Replacement service and repair

To keep the yield losses as low as possible in the case of a fault, we offer all our EU partners replacement devices. If a defective device cannot be repaired after expiry of the guarantee period, our Service Partners receive replacement devices under special conditions.



On-site customer service

If the Service Hotline and replacement service cannot correct your problems then our authorised Service Technicians will correct the problem on-site.



Workshops and seminars

As a Service Partner you are eligible to take part in our regular product training courses and receive information on new innovations.



Marketing tools

We support our Service Partners with professional marketing tools for the Web, trade fairs and communication.



Steca Service-Partner-Logo

As an authorised Service Partner, we allow you to use our logo on your advertising material.





»STECA SOLAR ELECTRONICS PRODUCTS AND SOLUTIONS FOR AN ECOLOGICAL FUTURE.«

Steca has long stood for ideas and innovations as an electronic manufacturing services (EMS) provider and manufacturer of Steca brand product lines in solar electronics and battery charging systems. As a leading supplier of products for the solar electronics industry, Steca sets the international standard for the regulation and control of solar energy systems. In the three market segments PV grid connected, PV off grid and Solar thermal, the Steca brand is synonymous with innovation and vision. In conception, development, production and marketing, the company is committed to the highest quality standards.

OTHER PRODUCT AREAS



PV OFF GRID

Solar home systems



Inverter systems



Hybrid systems



SOLAR THERMAL

Solar controllers

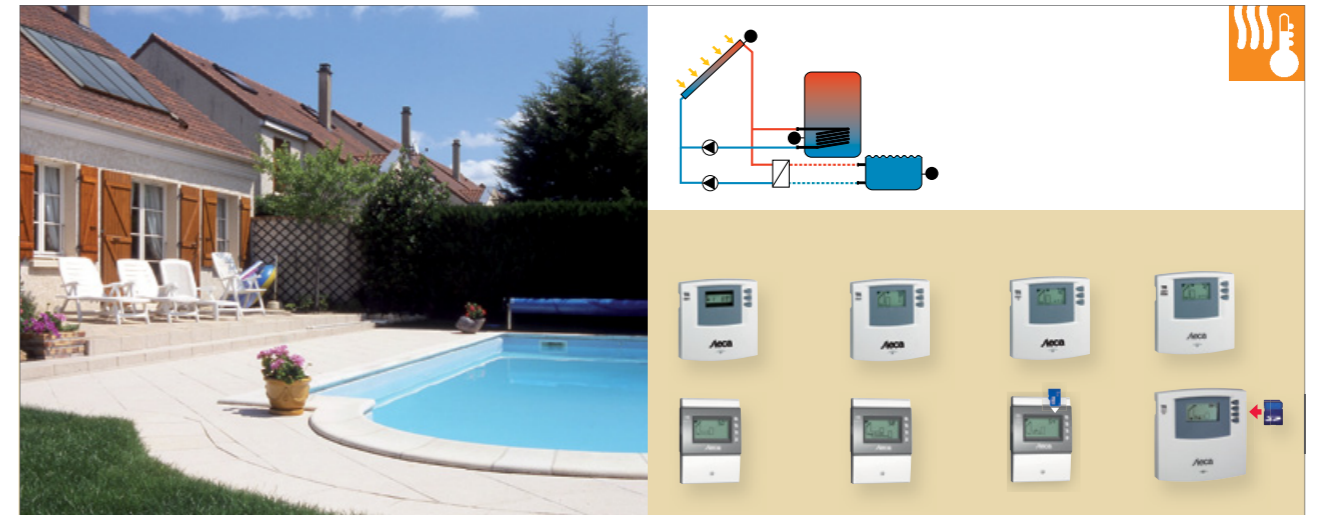

Heating and domestic hot water controllers



System controllers

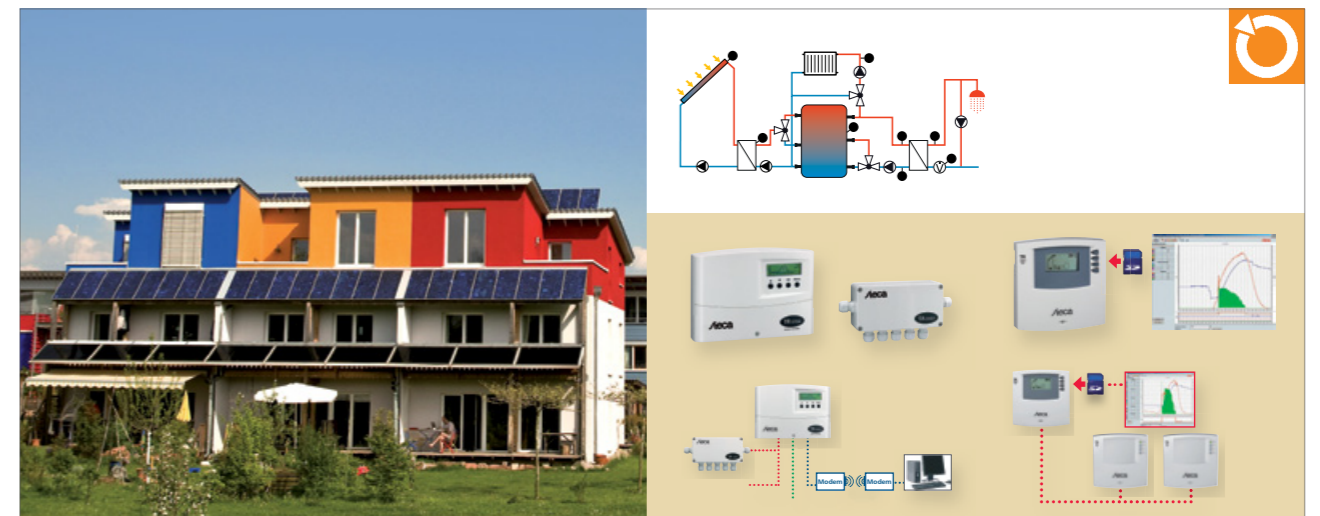



BATTERY CHARGING SYSTEMS

Mobile use



Stationary use



Equipment



ROOM FOR NOTES



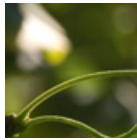

Steca
Elektronik

732.677 | 21.2012
© by Steca

Steca Elektronik GmbH
Mammostraße 1
87700 Memmingen
Germany
Fon +49-(0)8331-8558-0
Fax +49-(0)8331-8558-132

www.steca.com