



steca
www.steca.com

„PV Grid Connected – Power from the sun for everyday use.“



PV Grid Connected



Residential systems: single-family houses, apartment buildings, carports and garages



Commercial systems for agriculture and industry and ground-mounted installations



Steca – specialist in "difficult roofs"



Company

Content

	PV Grid Connected – Power from the sun ...	4
	Residential systems	6
	Overview of devices	7
	Commercial systems	8
	Overview of devices	9
	Steca – specialist in "difficult roofs"	10
	Overview of devices	11
	Yield analysis	12
	8.2 % more profit ...	
	Steca Solsafe	14
	Overview of devices	15
	Product information inverter systems	16
	StecaGrid 300 and StecaGrid 500	
	StecaGrid 300 and StecaGrid 500	20
	StecaGrid 300 Best in Test!	21
	StecaGrid ENS26	22
	StecaGrid ALD1	23
	DC circuit breaker	23
	StecaGrid 1900, StecaGrid 2000+, StecaGrid 2010+	
	StecaGrid 1900	24
	StecaGrid 2000+	26
	StecaGrid 2010+	28
	DC circuit breaker	30
	StecaGrid Connect PC network interface	31
	StecaGrid 9000 3ph, StecaGrid 10 000 3ph	
	StecaGrid 9000 3ph	32
	StecaGrid 10 000 3ph	34
	Meteocontrol WEB'log for remote monitoring	36
	StecaGrid Vision	37
	Software for professional system dimensioning	
	StecaGrid Configurator 3.0	38
	Service information	
	for StecaGrid inverter	39
	Environmental protection in series	40
	Steca product ranges	42
	Room for notes	45
	Symbols	47





Power from the sun ...

... for everyday use.

In one hour, the amount of energy radiated to the earth by the sun exceeds the annual energy requirement of the world population. Making use of this inexhaustible energy source for our everyday electricity requirement is the great challenge of the present and the future.

The energy crises of the 1970s and a general growing environmental awareness has also motivated politicians to push ahead with efforts to tap into the sun as an inexhaustible energy source and (as without financial incentives, it just won't work) to make this economically beneficial.



Steca Helix 1100
dating to 1996

Steca was quick to recognise the opportunities of a boom in the making: The company has become synonymous all over the world with vision, innovation, and initiative in the name of solar power. Steca is a recognised specialist in the development of high-performance systems which turn light into electricity before feeding it into the public grid.

30 years of experience

And not without reason: ever since the company was founded in 1976 – over 30 years ago, that is – Steca has developed inverter technologies and power electronics for heavy-duty operating conditions.

Thus, when the German federal government initiated the 1,000 Roofs Programme in the early 1990s, which supported photovoltaic systems nationwide for the first time in Germany, it was easy for the company to make a significant contribution: the majority of the inverters installed at that time came from Steca.

The energy sources of the future are renewable.

Residential systems



Commercial systems



Steca – specialist in "difficult roofs"



Product information inverter systems



Software for professional system dimensioning



Service information



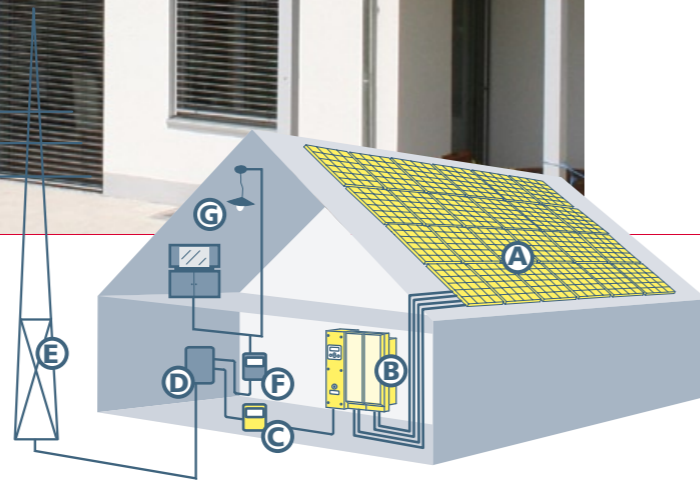

Residential systems

for single-family houses, apartment buildings, carports and garages.

It is now common knowledge that photovoltaics help preserve the climate and the environment. However, there are additional, far more decisive advantages which speak in favour of the installation of a PV system.

Photovoltaics are decentralised

Solar power is generated right where it is needed. This means: no energy losses and no costs for transmission and distribution.

Key:

- A Solar modules
- B Grid inverter
- C Grid-feed electricity meter
- D House connection point
- E Public electricity network
- F Consumption electricity meter
- G Electrical load



Overview of devices:



StecaGrid 300 and StecaGrid 500
Grid inverter
300 W - 3,600 W
(page 20)



StecaGrid 2010+
Grid inverter
2,000 W up to several 10,000 W
(page 28)

not shown:

- StecaGrid 2000+** (page 26)
- StecaGrid 1900** (page 24)

Solar power provides independence

Independence from the pricing arrangements of the large energy producers. Independence from energy policy in crisis countries, for instance in the Middle East. And last but not least: independence from the power outage risk of large electricity suppliers.

Simply generate electricity yourself!

Residential systems: in this market segment, photovoltaic systems are typically installed on single-family houses. But garages, carports and the roofs of apartment buildings are also suitable for electricity generation. The electricity is distributed locally throughout the settlement via the low voltage grid.

Here, there is a need for solutions adapted to the individual situation. Optimal yield with easy care and handling are criteria which count for the operators.



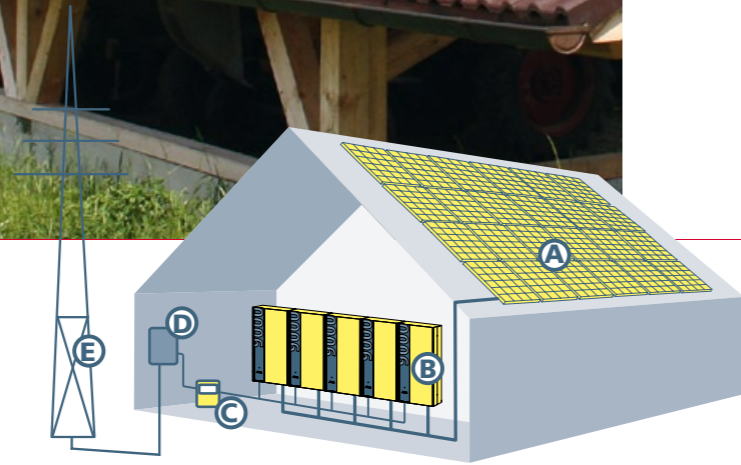

Commercial systems

for agriculture and industry and ground-mounted installations.

Solar energy systems are not only ecologically worthwhile and financially profitable – thanks to the feed-in tariffs which are legally guaranteed in numerous countries, they are one of the most secure capital investments worldwide: thus, an ever-increasing number of systems are being realised by commercial investors and investment funds.

Key:

- A Solar modules
- B Grid inverter
- C Grid-feed electricity meter
- D House connection point
- E Public electricity network



Overview of devices:



StecaGrid 2010+ Grid inverter
2,000 W up to several 10,000 W
(page 28)

not shown:
StecaGrid 2000+ (page 26)
StecaGrid 1900 (page 24)



StecaGrid 10000 3ph Grid inverter
10,000 W up to several 100,000 W
(page 34)

not shown:
StecaGrid 9000 3ph
(page 32)



Meteocontrol WEB'log for remote monitoring
(page 32)



StecaGrid Vision Display unit
(page 37)

Your yield always in view

Systems in this segment are installed on commercial buildings, agricultural buildings, or on the ground. In such cases, however, the system operator is often not the owner of the roof or surface. This in turn calls for professional remote system monitoring. In the event of a fault, an automatic alarm must immediately notify the system operator and possibly the installer as well.

First choice for thin-film modules

The occurrence of discharge current in a PV system is unavoidable. In the case of thin-film modules, this can lead to long-term damage and efficiency losses. The solution to this problem is an inverter with an integrated transformer: StecaGrid 2000+ with in-built transformer offers security at 95 % efficiency!



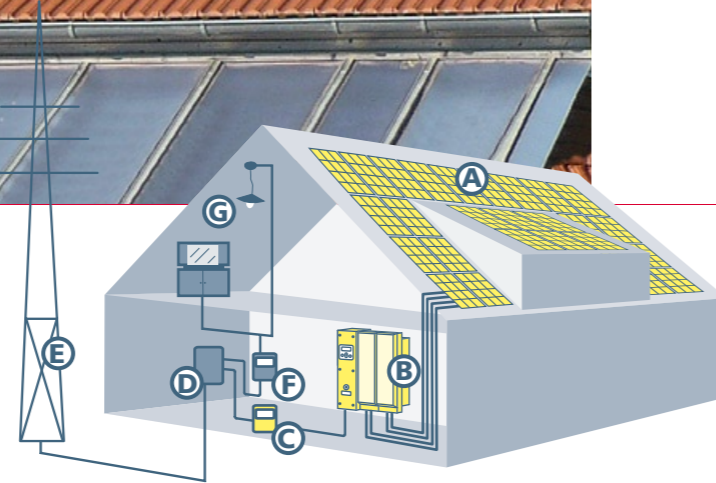

Specialist in difficult roofs

Systems for shading and differently aligned roof surfaces.

What is the point of having the largest, south-facing, optimally inclined 30° roof surface, if a neighbouring building, a tree, a street lamp, or even the roof's own chimney casts its shadow on the new solar energy system? That's like driving with the handbrake on!

Key:

- A Solar modules
- B Grid inverter
- C Grid-feed electricity meter
- D House connection point
- E Public electricity network
- F Consumption electricity meter
- G Electrical load



Overview of devices:



StecaGrid 300 and StecaGrid 500
Grid inverter
300 W - 3,600 W
(page 20)



StecaGrid 2010+
Grid inverter
2,000 W up to several 10,000 W
(page 28)

not shown:

- StecaGrid 2000+** (page 26)
- StecaGrid 1900** (page 24)

Shadows waste money

As the weakest solar cell determines the total output of a whole module, even the shadow of a roof antenna can reduce the yield of a PV system by up to 20 percent!

Thus, before installation, it is important to ascertain what objects in the system's surroundings can cause shading and to dimension the system accordingly.

As a specialist in situations of this kind, Steca develops individual solutions.





8.2 % more profit ...

... in the event of shading, due to a cleverly connected StecaGrid 2000+ inverter

Steca has further underlined its position as a specialist in difficult roofs. A simulation, which an independent institute was commissioned to conduct, showed that in shaded locations, the inverter StecaGrid 2000+, with four MPP trackers, feeds 8.2 percent more electricity into the grid each year than an inverter with one MPP tracker.



The test setup was realised on a roof, on which a dormer cast its shadow on the generator surface in the mornings and evenings. The company Solarschmiede, responsible for the simulation, assessed two 4 kW systems. In the first, the staff connected a 4,040 W (DC) inverter with a single MPP tracker for three parallel strings. In the second system, they installed the StecaGrid 2000+ with four MPP trackers – one for each of the four inputs. Even in the absence of shading, the Steca inverter's decrease in yield compared to the conventional system was just 1.7 percent. The simulation showed that if shading does occur, using the Steca inverter really pays off. With 8.2 percent more yield per annum, even installations on difficult roofs become profitable.

And one thing is clear: site-specific shading is caused not only by dormers, but also by neighbouring buildings, chimneys, trees, masts or antennas.

Up to 6 kW, the user benefits from the Steca system's unit, which is more compact than conventional systems with four individual devices: one display and one AC connection on the grid side guarantee lower procurement and maintenance costs.

Simulation and analysis of a shading situation for a grid-connected PV system by order of Steca Elektronik GmbH.

Download report at www.stecasolar.com

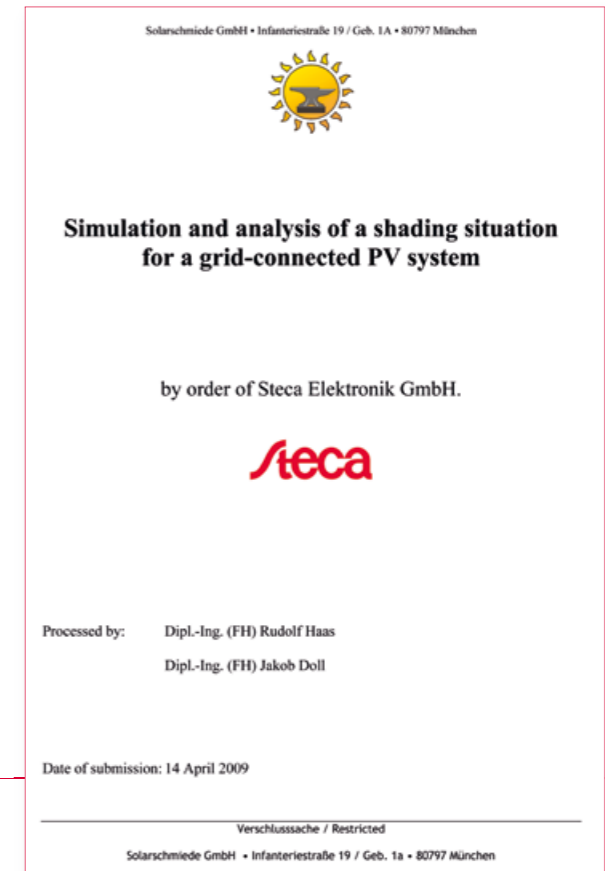

Summary of results and conclusion

The analysis of the two provided connection schemes for 27 example modules with two StecaGrid 2000+ inverters (Master and Slave) and one example string inverter (hereinafter referred to as ESI) produces the result which is to be expected. In the absence of shading, the ESI achieves an almost 2% higher yield than the two StecaGrid 2000+ inverters, due to its higher efficiency. In the actual case in question, in which a dormer casts a shadow on the generator surface in the mornings and evenings, the StecaGrid 2000+ inverters (which use multi-MPP trackers) achieve a higher yield than the ESI (which uses 1 MPP tracker for 3 parallel strings). With an annual energy yield of 4,189.6 kWh, they could feed around 8.2 % more energy into the grid than the ESI (3,872.2 kWh)¹. This difference is due to the ESI's universal shifting of the MPP point in the event of shading. With an approximately 8.2 % higher yield, the connection scheme with the StecaGrid 2000+ inverters clearly shows that the use of a multi-MPPT inverter is worthwhile in the event of shading, even if the difference in efficiency is greater than that of the two tested inverters. Furthermore, the fact that in this shading situation the StecaGrid 2000+ inverters achieve a yield which is only 1.7 % lower than in the absence of shading, is indicative of

the shading tolerance of the multi-MPPT inverters. However, it must also be noted that the mismatch losses of the string (ESI) in which 35° modules are connected to 20° modules were not taken into account, so the difference in annual energy yield compared to the StecaGrid 2000+ inverters will be even higher.

String connection of the 27 modules on the StecaGrid 2000+ inverters

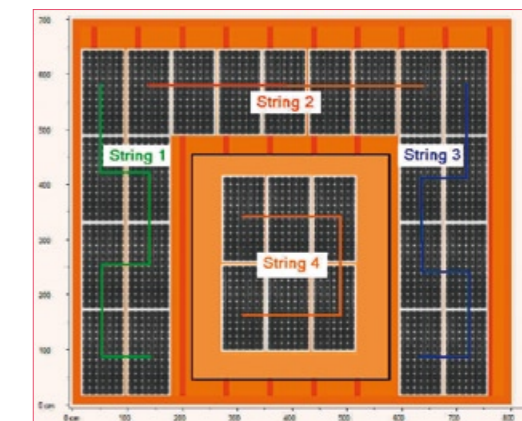

¹ With the simulation program PVSYS, the annual energy yield of the ESI in the case of shading is 3810.24 kWh, thereby showing yield losses of around 10 % compared to the StecaGrid 2000+.



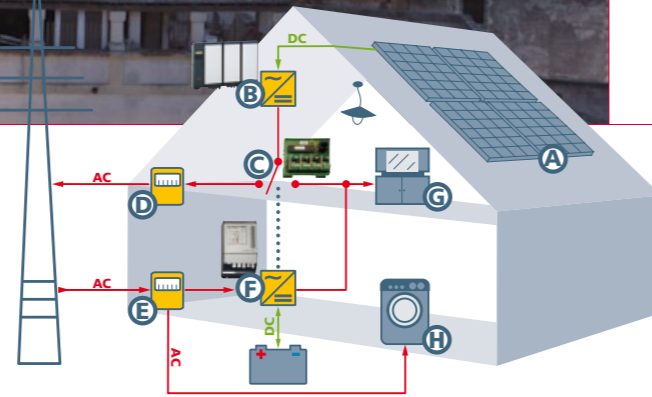
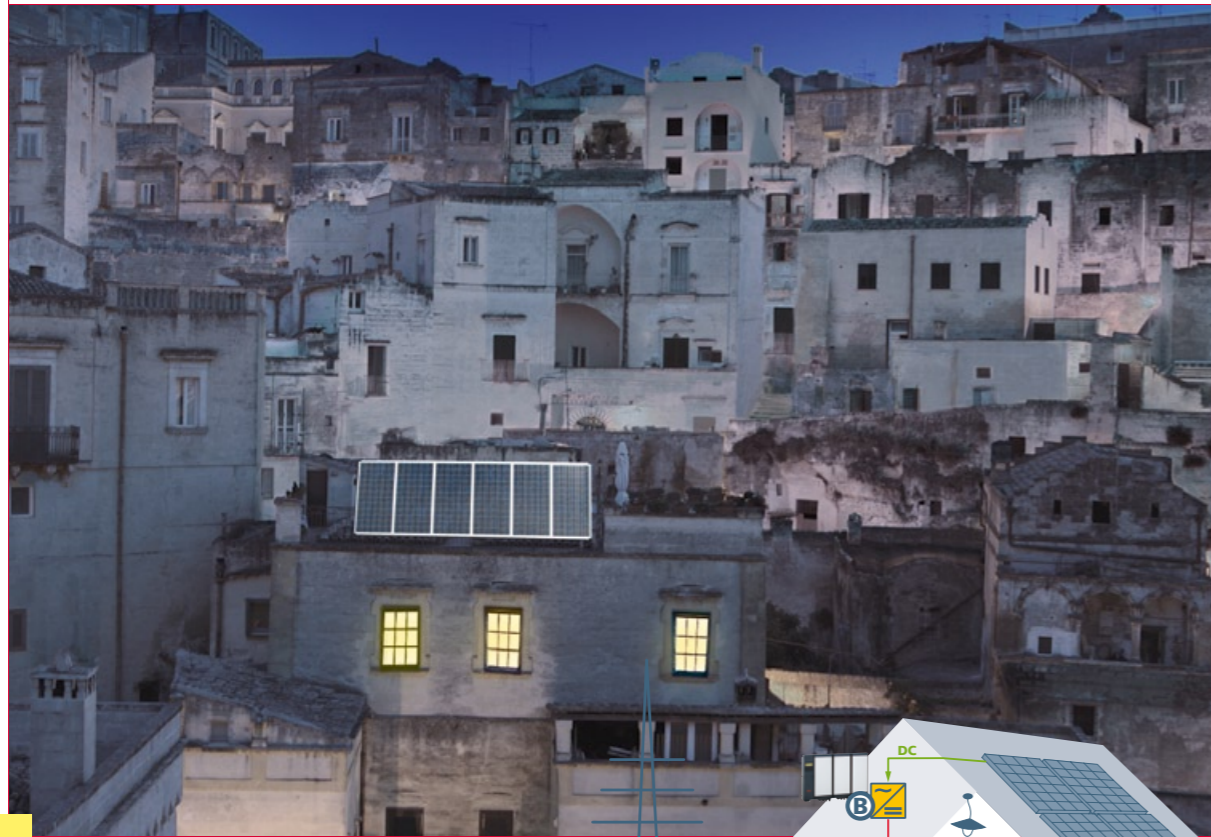

Steca Solsafe

Blackout - and yet it stays light!

Large-scale power supply failures are becoming increasingly common. With emergency systems such as generators or uninterruptible power supplies (UPS), the power supply can be assured.

Yet, in the event of a power outage, the grid-connected PV system also stops working. This means that although power may be available, it cannot be used. The Solsafe system offers a simple, efficient and cost-effective solution to this problem.

Installing one of our combined inverters Steca XPC, Steca Compact, Steca HPC, Steca Xtender XTM or Steca Xtender XTH with the supplementary ARM-01 relay module and a battery system turns any grid-connected PV system into an emergency power supply in the event of a power outage. If the public grid is available, the electrical output generated by the solar modules is fed directly into the grid by the grid inverter (B) and the grid-feed electricity meter (D). In parallel to this, the unsupplied loads (H) receive power directly from the grid, via the consumption electricity meter (E). The batteries are kept fully charged from the public grid via the hybrid system inverter (F), and, if necessary, they are recharged. Furthermore, the supplied loads (G) receive power from the public grid during transfer mode.

Key:

- A Solar modules
- B Grid inverter
- C Relay module ARM-01
- D Grid-feed electricity meter
- E Consumption electricity meter
- F Sine wave inverter
- G Supplied loads
- H Unsupplied loads

If there is a grid outage, the hybrid system inverter automatically switches mode to operate as a sine wave inverter, and continues to feed power to the supplied loads (G) without any interruption. Because the grid inverter can no longer supply power to the grid, its output is channelled directly to the supplied loads (G) by the ARM-01 relay module (C). In this way, the loads can receive power directly from the grid inverter of the solar modules. At the same time, the battery can be recharged with the available solar energy, which increases the length of time for which the supplied loads can receive power during the night.

With this set-up, the capacity of the battery can be kept small, allowing for an optimal design of system costs.

The Solsafe system is fully automatic, and can be integrated into any new or existing PV system.

Solsafe ensures the power supply, and furthermore allows the solar energy to be fully utilised.

Overview of devices:

 Steca XPC Sine wave inverter 1,400 W - 2,200 W <i>(Steca PV Off Grid)</i>	 Steca Compact Sine wave inverter 1,600 W - 4,000 W <i>(Steca PV Off Grid)</i>	 Steca HPC Sine wave inverter 2,800 W - 8,000 W <i>(Steca PV Off Grid)</i>	 ARM-01 Relay module for Steca sine wave inverter	 Solasafe 5-Box Anti-blackout system for Steca sine wave inverter
 Steca Xtender XTM Sine wave inverter 1,500 W - 36,000 W <i>(Steca PV Off Grid)</i>	 Steca Xtender XTH Sine wave inverter 3,000 W - 72,000 W <i>(Steca PV Off Grid)</i>	 StecaGrid 300 and StecaGrid 500 Grid inverter 300 W - 3,600 W <i>(page 20)</i>	 StecaGrid 2010+ Grid inverter 2,000 W up to several 10,000 W <i>(page 28)</i>	 StecaGrid 10000 3ph Grid inverter 10,000 W up to several 100,000 W <i>(page 34)</i>
			<i>not shown:</i> StecaGrid 2000+ <i>(page 26)</i> StecaGrid 1900 <i>(page 24)</i>	<i>not shown:</i> StecaGrid 9000 3ph <i>(page 32)</i>

Why choose Steca Solsafe?

- It allows great system flexibility. The grid inverter is designed according to the PV generator, and the sine wave inverter according to the desired emergency power supply.
- The PV system's output and operating voltage can be freely selected, and do not depend on the size and battery voltage of the emergency power supply. It should be noted, however, that the AC output of the grid inverter may never be greater than the rated output of the sine wave inverter.
- The PV voltage of the grid inverter does not depend on the battery voltage.
- Existing grid-connected solar power systems can be fitted with Steca Solsafe without alterations of any kind.
- The available PV capacity is added to that of the sine wave inverter in the event of a power outage, or the solar power is stored in the battery.





StecaGrid 300/500

... modular and flexible.

The StecaGrid 300 and StecaGrid 500 inverters are perfectly suited to smaller solar power systems starting at 300 W. Thanks to the modularity, this is the inverter of choice in systems with differently aligned or partially shaded roofs, and on smaller surfaces (garage roofs, summer houses).

The inverters StecaGrid 300 and StecaGrid 500 were developed to make the use of solar energy as simple as possible. They are simple to install, easy to expand, and can be optimally adjusted to suit the local irradiation conditions.



Every roof is unique ...

This calls for individual solutions.

To achieve this, Steca has developed modular components which offer made-to-measure solutions for the widest range of household sizes and demands. Whether being used in a small solar power system for a single-family house or an elaborate combined solution for an industrial complex, Steca grid-feed inverters all have one thing in common: They offer the highest performance along with maximum flexibility and ease of use.

Together with their range of accessories, the StecaGrid inverters represent an innovative family of inverter solutions for grid-connected solar power systems.

The modular concept offers you over 100 different possibilities for designing an inverter system tailored to your individual needs. With MiniString, DualString, or UniString inverters, Steca always offers you the optimal inverter for your system.

Maximum flexibility for maximum results

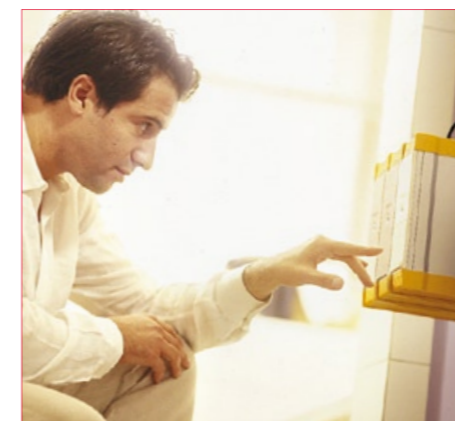



StecaGrid 2010+

... for universal use.

StecaGrid 1900, StecaGrid 2000+ and StecaGrid 2010+ are designed for solar power systems from 1,840 W upwards. These inverters are also the first choice in situations where the roof conditions are difficult, such as partially shaded or differently aligned roof surfaces. For the home owner and for the farmer.

A Master can be supplemented by one or two additional Slaves, so that inverter units with approx. 4,000 or 6,000 W can be realised. Several MasterSlave combinations can be used within a single system.



StecaGrid 2010+ D Master and 2 StecaGrid 2010+ Slaves



StecaGrid 10000 3ph

... always symmetrical.

For larger solar power systems, StecaGrid 9000 3ph and StecaGrid 10000 3ph are the ideal devices. They enable the creation of systems from 10 kWp to several hundred kWp. These inverters are primarily used in systems on industrial roofs, agricultural buildings and in ground-mounted systems. Prerequisite: identical module orientation in each case, with no shadow problems.



StecaGrid 10 000 3ph



StecaGrid 300 and StecaGrid 500

The MiniString inverter series comprises the StecaGrid 300 and StecaGrid 500 inverters, with rated outputs of 300 W and 500 W, respectively.

StecaGrid 300 and StecaGrid 500 are built in a modular manner, and simple to install. With distribution over three phases, the system can at any time be expanded as desired, and thus flexibly adapts to your solar power system investment. StecaGrid 300 and StecaGrid 500 have an independent MPP tracker and achieve a very high efficiency of up to 95.8 %.

Product features

- Flexible and expandable
- High efficiency
- MiniString concept
- Low weight
- Simple installation
- Wall-mounting with top-hat rail

Electronic protection functions

- Integrated temperature monitoring with output derating

Displays

- Multi-coloured LED shows operating status

Options

- United Kingdom variants as per G83 available

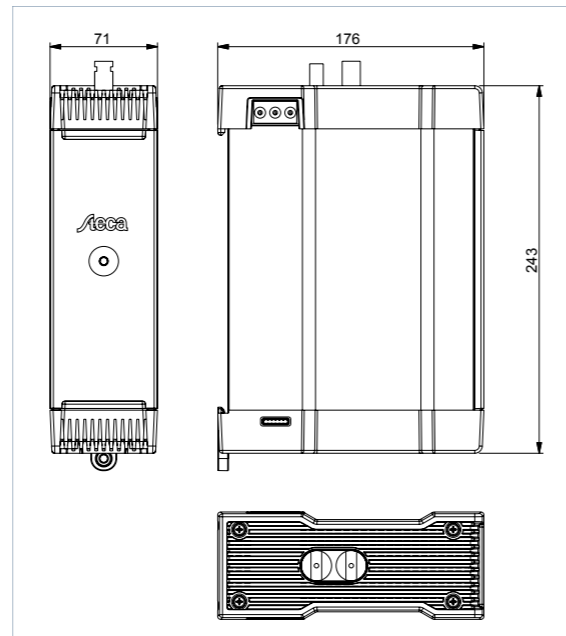

StecaGrid 300 Best in Test !

Most efficient inverter

The StecaGrid 300 inverter was the top performer in a test of small grid-connected inverters and solar modules conducted by the renowned Paul Scherrer Institut in Switzerland. The testers determined that the test winner from the Memmingen-based Steca solar electronic company was the most efficient in its class. According to study data, the efficiency of the StecaGrid 300 rises relatively quickly and remains at a constantly high level. It won the top spot among the tested devices with 93.5 per cent.

The StecaGrid 500 was also awarded high marks in the test. This was confirmed in a report by the Swiss trade journal „Erneuerbare Energien“ („Renewable Energy“) on the efficiency of solar power systems. In the December 2007 issue the journal came to the conclusion that „according to our measurements the StecaGrid inverters were clearly the best performers.“ The test report of the Paul Scherrer Institut can be downloaded at http://tpv-pv.web.psi.ch/grid_pv.pdf The StecaGrid 300 and 500 have not just proved to be particularly efficient; they also stand out with their flexibility. The modularity of MiniString inverters makes them ideal for garages, carports, terraced and single-family houses. Moreover, due to the short strings and numerous MPP trackers, they are very well suited for small-section or partially shaded roofs.

	StecaGrid 300	StecaGrid 500
DC input side (PV-generator)		
Maximum start voltage	100 V	170 V
Maximum input voltage	135 V	230 V
Minimum input voltage	45 V	75 V
Minimum input voltage for rated output	64 V	106 V
MPP voltage	45 V ... 100 V	75 V ... 170 V
Maximum input current	5 A	
Maximum input power	320 W	530 W
Maximum recommended PV power	375 Wp	625 Wp
Derating / limiting	automatic when - input power is higher - the device is not cooled sufficiently - input currents > 5 A (higher currents are limited by the equipment and therefore will not damage the inverter)	
AC output side (Grid connection)		
Grid voltage	207 V ... 253 V [other values are possible]	
Rated grid voltage	230 V	
Maximum output current	1.5 A	2.5 A
Maximum output power	300 W	500 W
Rated power	300 W	500 W
Rated frequency	50 Hz	
Frequency	48 Hz ... 52 Hz [other values are possible]	
Night-time power loss	< 0.1 W	
Feeding phases	single-phase	
Power factor	> 0.95	
Distortion factor	< 6 % (max. power)	< 5 % (max. power)
Characterisation of the operating performance		
Maximum efficiency	94.8 %	95.8 %
European efficiency	93.4 %	94.5 %
MPP efficiency	99 %	
Power derating at full power	from 40 °C	
Switch-on power	2 W	
Standby power	0 W	

	StecaGrid 300	StecaGrid 500
Safety		
Isolation principle	no galvanic isolation, transformerless	
Grid monitoring	optional via StecaGrid ENS 26	
Operating conditions		
Area of application	indoor rooms, with or without air conditioning	
Ambient temperature	-20 °C ... +45 °C	
Relative humidity	0 % ... 95 %	
Noise emission	< 32 dBA	
Fitting and construction		
Degree of protection	IP 20	
DC input side connection	MultiContact MC 3, MC 4	
AC output side connection	Wieland Electric GST 18i3V plug	
Dimensions (X x Y x Z)	176 x 243 x 71 mm	
Weight	1.4 kg	
DC circuit breaker	no	
Cooling principle	natural convection	
Test certificate	CE mark, DK 5940	



StecaGrid ENS26

The automatic, one-phase isolation unit is an automatic switching unit used to connect decentralised power generators safely to the public electricity supply.

The StecaGrid ENS26 isolation unit has been conceived as an independent unit for monitoring one-phase power feeding systems. It prevents uncontrolled island effects following failure or shutdown of the public electricity supply.

The StecaGrid ENS26 complies with DIN VDE 0126-1-1 and is approved as a substitute for manual isolation devices up to a 5.75 kW feeding power.

The StecaGrid ENS26 automatic isolation unit continually monitors

- overvoltage and undervoltage
- frequency deviation
- impedance jumps

in the public electricity supply.

In the event of faults in the mains supply, the StecaGrid ENS26 interrupts the feeding of electricity in the mains to prevent island effects.

The disconnection of L and N is accomplished by two relays. Each relay is specified for a switching current of 25 A.

The contact distance within the relay is in accordance to the overvoltage category 2 at 250 V AC.

The safety functions are executed in a dual channel system, whereby each channel monitors the proper function of the other channel. In case of a failure the channels disconnect independently from each other.

The channels monitor each other mutually (refer to the error protection in accordance with DIN VDE 0126) to increase error protection.

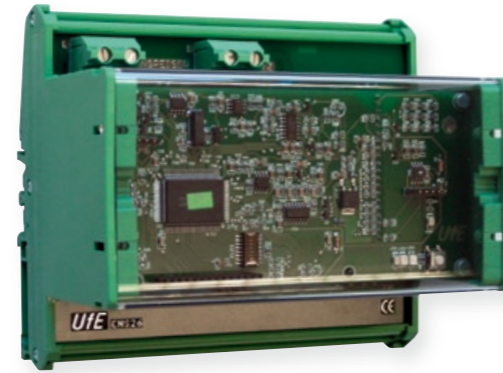

StecaGrid ENS26	
AC output side (Grid connection)	
Rated grid voltage	230 V
Rated frequency	50 Hz
Characterisation of the operating performance	
Switched power	< 5,750 W
Rated current of power feeder	< 25 A
Own consumption	1.5 W
Safety	
Grid monitoring	compliant with DIN VDE 0126-1-1
Overvoltage (fast shutdown)	> 300 V (response time 0.02 s)
Overvoltage	> 264 V (response time 0.2 s)
Overvoltage	230 V +10 % over 10 min.
Undervoltage (fast shutdown)	< 130 V (response time 0.02 s)
Undervoltage	< 185 V (response time 0.2 s)
Frequency deviation	+0.2 Hz / -2.5 Hz (response time 0.2 s)
Rate of Change of Frequency (RoCoF)	> 1 Hz / s
Impedance jump detection	> 0.5 Ohm (response time 0.5 s)
Operating conditions	
Ambient temperature	-20 °C ... +40 °C
Relative humidity	10 % ... 90 %, non-condensating
Fitting and construction	
Dimensions (X x Y x Z)	146 x 111 x 80 mm
Test certificate	certificate of compliance, CE mark

StecaGrid ALD1

Digital energy meter

StecaGrid ALD1	
AC output side (Grid connection)	
Rated grid voltage	230 V (-20 % / +15 %)
Rated frequency	50 Hz
Rated current	5 A
Measurement current	32 A
Starting current	20 mA
Minimum current	0.25 A
Power consumption	active 0.4 W
Characterisation of the operating performance	
Accuracy class	1 (1 %) as per IEC 62 053-21 or B in accordance with EN 50 470-3 (devices in accordance with MID)
Measurement	direct
Safety	
Protection class	II
Insulation characteristics	4 kV / 50 Hz test in accordance with VDE 0435 6 kV 1.2 / 50 µs surge voltage in accordance with IEC 255-4
Operating conditions	
Ambient temperature	-10 °C ... +55 °C
Storage temperature	-30 °C ... +85 °C
Relative humidity	95 % at 25 °C ... 40 °C, non-condensating
Fitting and construction	
Terminal (fine / single wire)	primary circuit: max. 6 mm ² impulse output: max. 2,5 mm ²
Dimensions (X x Y x Z)	17.5 x 89.2 x 63.4 mm
S0 output	optocoupler max. 30 V / 20 mA and min. 5 V, impedance 100 Ω, impulse range 50 ms, transmission distance max. 1,000 m (at 30 V / 20 mA)
Pulses per kWh	2,000 (LC display), 1,000 (S0 output)
Test certificate	CE mark

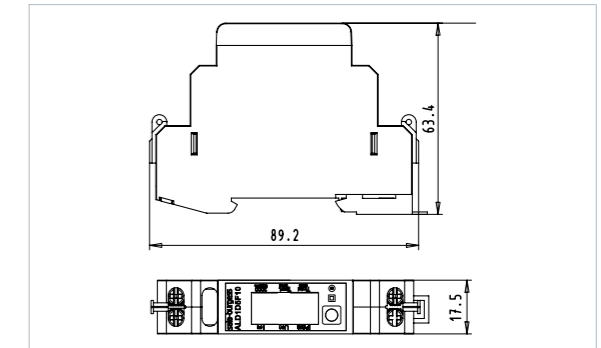
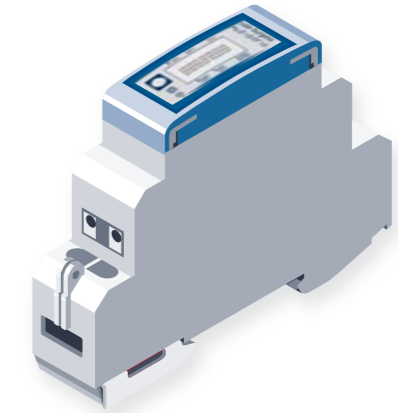

Product features

- Wall-mounting with top-hat rail

Displays

- LCD display with backlight, digits 5 mm high

DC circuit breaker for StecaGrid 300 and StecaGrid 500

250 V DC, 6 A DC, 6-pole

One DC circuit breaker can be used for one to three inverters. If the inputs are single-phased, up to six inverters can be connected via one DC circuit breaker.

Certificates

- Compliant with DIN VDE 0100-712

DC circuit breaker for StecaGrid 300 and StecaGrid 500	
DC input side (PV-generator)	
Maximum input voltage	250 V
Maximum input current	6 A per contact
Operating conditions	
Area of application	indoor rooms, with or without air conditioning, outdoors with or without protection
Ambient temperature	-40 °C ... +60 °C
Relative humidity	0 % ... 95 %
Fitting and construction	
Degree of protection	IP 65
Terminal (fine / single wire)	10 mm ² / 16 mm ²
Dimensions (X x Y x Z)	125 x 200 x 122 mm
Weight	1.2 kg
Test certificate	CE mark



► Wiring information for the DC circuit breaker can be found on our website (www.steca.com).



StecaGrid 1900

1,840 W up to several 10,000 W

The DualString product range consists of masters and slaves. Like the slaves, the master includes an inverter, but it also provides additional functions: a four-line display, a data logger for storing the yield values, country-specific grid monitoring of the alternating current output, and optional use of an interface card.

Flexible system design

The StecaGrid 1900 uses the DualString concept. This means that every inverter (master or slave) has two inputs, with each input having its own MPP tracker. One module string can be connected to each input. If required, the inputs can also be connected in parallel.

The advantage of such a system is the low sensitivity to negative influences such as (e.g.) partial shadowing, functional faults, or the dropout of a string. The use of several decentralised master-slave combinations reduces the cost of DC cabling, and minimises electrical losses.

Galvanic isolation

DualString inverters from Steca are equipped with a high-frequency transformer, and are thus galvanically isolated. This enables unrestricted use of thin-film modules. Nevertheless, high efficiency of up to 95 % is achieved.

Diverse application situations

StecaGrid inverters offer constant high-power capability over a wide range of ambient temperatures. This is supported by maintenance-free, natural convection via the large-dimension cooling fins. Since no fans are used, the inverters work in virtual silence. Thanks to the high degree of protection, StecaGrid DualString inverters are also suitable for outdoor installation.

StecaGrid 1900 D Master can be combined with StecaGrid 2000+ Slave and StecaGrid 2010+ Slave.

Product features

- Two Maximum Power Point Trackers (MPP tracker) per device
- Flexible and expandable
- High efficiency
- DualString concept
- Low weight
- Simple installation
- MasterSlave concept
- Suitable for outdoor installation
- Fanless and maintenance-free
- Integrated data logger
- Wall-mounting with steel wall bracket for very easy installation

Electronic protection functions

- Integrated temperature monitoring with output derating



StecaGrid 1900 D Master

StecaGrid 1900 Slave

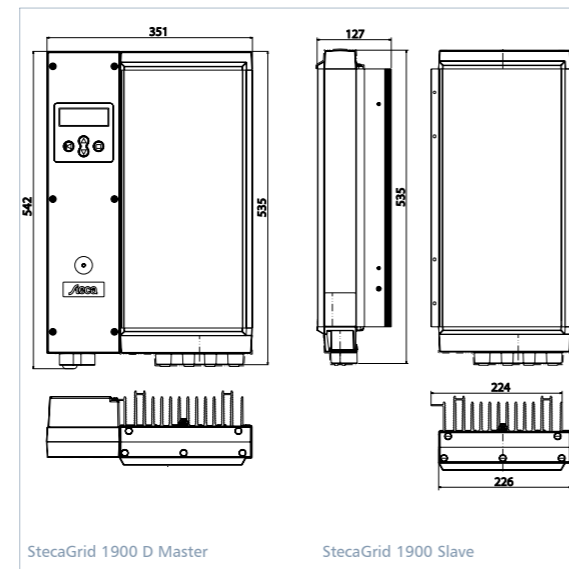

StecaGrid 1900 D Master

StecaGrid 1900 Slave

Displays

- Text LCD display
 - for current output, energy yields, operating parameters, date, time, service information
- Multi-coloured LED shows operating states

Operation

- Multilingual menu navigation
- Four cursor buttons for menu selection

	StecaGrid 1900 D Master	StecaGrid 1900 Slave
DC input side (PV-generator)		
Maximum start voltage	410 V	
Maximum input voltage	450 V (higher voltages can damage the device)	
Minimum input voltage	80 V	
Minimum input voltage for rated output	132 V	
MPP voltage	80 V ... 400 V	
Maximum input current	2 x 8 A [current limited by inverter] or 1 x 16 A [parallel inputs]	
Maximum input power	1,000 W [per input] or 2,000 W [2 parallel inputs]	
Maximum recommended PV power	2,200 Wp	
Derating / limiting	automatic when <ul style="list-style-type: none"> - input power is higher (> 1,000 W / input) - the device is not cooled sufficiently - input currents > 2 x 8 A or 1 x 16 A (parallel inputs) (higher currents are limited by the equipment and therefore will not damage the inverter)	
AC output side (Grid connection)		
Grid voltage	190 V ... 265 V [depending on regional settings]	
Rated grid voltage	230 V	
Maximum output current	10 A	
Maximum output power	1,840 W	
Rated power	1,840 W	
Rated frequency	50 Hz	
Frequency	47.5 Hz ... 52 Hz [depending on regional settings]	
Night-time power loss	1.3 W	0 W
Feeding phases	single-phase	
Power factor	> 0.95	
Distortion factor	< 5 % (max. power)	
Characterisation of the operating performance		
Maximum efficiency	95 %	
European efficiency	93.3 %	93.5 %
MPP efficiency	> 99 %	
Power derating at full power	from 45 °C (T _{amb})	
Switch-on power	20 W	
Standby power	3 W	
Safety		
Isolation principle	HF-transformer with galvanic separation and amplified isolation	
Grid monitoring	MSD, compliant with DIN VDE 0126-1-1	via master
Selectable parameter settings	Greece, France, Spain, Portugal, Italy, Great Britain	via master
Operating conditions		
Area of application	indoor rooms with or without air conditioning, outdoors with or without protection	
Ambient temperature	-25 °C ... +60 °C	
Relative humidity	0 % ... 95 %	
Noise emission	< 32 dBA	
Fitting and construction		
Degree of protection	IP 65	
DC Input side connection	MultiContact MC 4	
AC output side connection	WAGO 2.5 mm ² ... 6 mm ²	via master
Dimensions (X x Y x Z)	351 x 542 x 140* mm	226 x 535 x 140* mm
Weight	approx. 11 kg	approx. 9 kg
Communication interface	optional StecaGrid Connect with Ethernet interface	
DC circuit breaker	no	
Cooling principle	natural convection	
Test certificate	certificate of compliance, CE mark	

*incl. mounting plate

StecaGrid 1900: Master-Slave combination



StecaGrid 1900 D Master and 2 StecaGrid 1900 Slaves

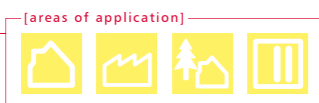

StecaGrid 2000+

2,000 W up to several 10,000 W

The DualString product range consists of masters and slaves. Like the slaves, the master includes an inverter, but it also provides additional functions: a four-line display, a data logger for storing the yield values, country-specific grid monitoring of the alternating current output, and optional use of an interface card.

Flexible system design

The StecaGrid 2000+ uses the DualString concept. This means that every inverter (master or slave) has two inputs, with each input having its own MPP tracker. One module string can be connected to each input. If required, the inputs can also be connected in parallel.

The advantage of such a system is the low sensitivity to negative influences such as (e.g.) partial shadowing, functional faults, or the dropout of a string. The use of several decentralised master-slave combinations reduces the cost of DC cabling, and minimises electrical losses.

Galvanic isolation

DualString inverters from Steca are equipped with a high-frequency transformer, and are thus galvanically isolated. This enables unrestricted use of thin-film modules. Nevertheless, high efficiency of up to 95 % is achieved.

Diverse application situations

StecaGrid inverters offer constant high-power capability over a wide range of ambient temperatures. This is supported by maintenance-free, natural convection via the large-dimension cooling fins. Since no fans are used, the inverters work in virtual silence. Thanks to the high degree of protection, StecaGrid DualString inverters are also suitable for outdoor installation.

StecaGrid 2000+ D Master and StecaGrid 2000+ Master can be combined with StecaGrid 1900 Slave and StecaGrid 2010+ Slave.

Product features

- Two Maximum Power Point Trackers (MPP tracker) per device
- Flexible and expandable
- High efficiency
- DualString concept
- Low weight
- Simple installation
- MasterSlave concept
- Suitable for outdoor installation
- Fanless and maintenance-free
- Integrated data logger
- Wall-mounting with steel wall bracket for very easy installation

Electronic protection functions

- Integrated temperature monitoring with output derating



StecaGrid 2000+ Master

StecaGrid 2000+ Slave

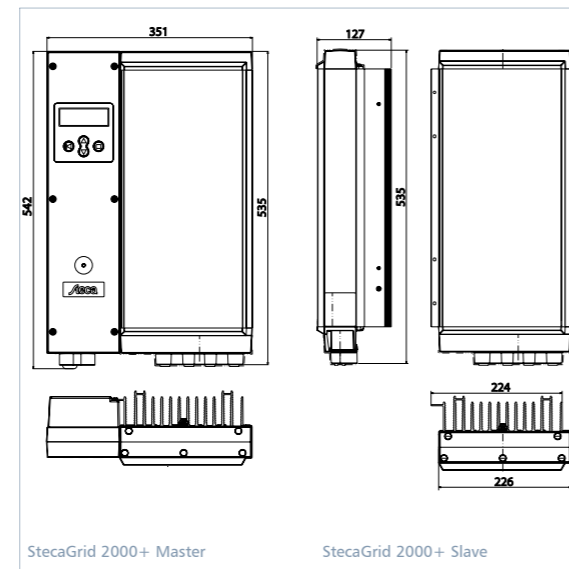

StecaGrid 2000+ Master

StecaGrid 2000+ Slave

Displays

- Text LCD display
 - for current output, energy yields, operating parameters, date, time, service information
- Multi-coloured LED shows operating states

Operation

- Multilingual menu navigation
- Four cursor buttons for menu selection

Options

- Type with 230 V / 60 Hz

	StecaGrid 2000+ D Master	StecaGrid 2000+ Master	StecaGrid 2000+ Slave
DC input side (PV-generator)			
Maximum start voltage	410 V		
Maximum input voltage	450 V (higher voltages can damage the device)		
Minimum input voltage	80 V		
Minimum input voltage for rated output	132 V		
MPP voltage	80 V ... 400 V		
Maximum input current	2 x 8 A [current limited by inverter] or 1 x 16 A [parallel inputs]		
Maximum input power	1,075 W [per input] or 2,150 W [2 parallel inputs]		
Maximum recommended PV power	2,400 Wp		
Derating / limiting	automatic when - input power is higher (> 1,075 W / input) - the device is not cooled sufficiently - input currents > 2 x 8 A or 1 x 16 A (parallel inputs) (higher currents are limited by the equipment and therefore will not damage the inverter)		
AC output side (Grid connection)			
Grid voltage	190 V ... 265 V [depending on regional settings]		
Rated grid voltage	230 V		
Maximum output current	10 A		
Maximum output power	2,000 W		
Rated power	2,000 W		
Rated frequency	50 Hz, optional 60 Hz		
Frequency	47.5 Hz ... 52 Hz [depending on regional settings]		
Night-time power loss	1.3 W	1.0 W	0 W
Feeding phases	single-phase		
Power factor	> 0.95		
Distortion factor	< 5 % (max. power)		
Characterisation of the operating performance			
Maximum efficiency	95 %		
European efficiency	93.3 %		93.5 %
MPP efficiency	> 99 %		
Power derating at full power	from 40 °C (T _{amb})		
Switch-on power	20 W		
Standby power	3 W		
Safety			
Isolation principle	HF-transformer with galvanic separation and amplified isolation		
Grid monitoring	MSD, compliant with DIN VDE 0126-1-1	see table of countries	via master
Selectable parameter settings	Netherlands, Belgium, France, Spain, Great Britain, Germany (Type with 60 Hz: DOM-TOM, Costa Rica)		via master
Operating conditions			
Area of application	indoor rooms with or without air conditioning, outdoors with or without protection		
Ambient temperature	-25 °C ... +60 °C		
Relative humidity	0 % ... 95 %		
Noise emission	< 32 dBA		
Fitting and construction			
Degree of protection	IP 65		
DC Input side connection	MultiContact MC 4		
AC output side connection	WAGO 2.5 mm ² ... 6 mm ²		via master
Dimensions (X x Y x Z)	351 x 542 x 140* mm		226 x 535 x 140* mm
Weight	approx. 11 kg		approx. 9 kg
Communication interface	optional StecaGrid Connect with Ethernet interface		
DC circuit breaker	no		
Cooling principle	natural convection		
Test certificate	certificate of compliance, CE mark		

*incl. mounting plate

StecaGrid 2000+: Master-Slave combination



StecaGrid 2000+ Master and 2 StecaGrid 2000+ Slaves

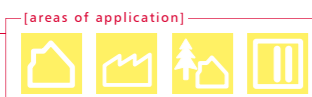

StecaGrid 2010+

2,000 W up to several 10,000 W

The DualString product range consists of masters and slaves. Like the slaves, the master includes an inverter, but it also provides additional functions: a four-line display, a data logger for storing the yield values, country-specific grid monitoring of the alternating current output, and optional use of an interface card.

Flexible system design

The StecaGrid 2010+ uses the DualString concept. This means that every inverter (master or slave) has two inputs, with each input having its own MPP tracker. One module string can be connected to each input. If required, the inputs can also be connected in parallel.

The advantage of such a system is the low sensitivity to negative influences such as (e.g.) partial shadowing, functional faults, or the dropout of a string. The use of several decentralised master-slave combinations reduces the cost of DC cabling, and minimises electrical losses.

Galvanic isolation

DualString inverters from Steca are equipped with a high-frequency transformer, and are thus galvanically isolated. This enables unrestricted use of thin-film modules. Nevertheless, high efficiency of up to 95 % is achieved.

Diverse application situations

StecaGrid inverters offer constant high-power capability over a wide range of ambient temperatures. This is supported by maintenance-free, natural convection via the large-dimension cooling fins. Since no fans are used, the inverters work in virtual silence. Thanks to the high degree of protection, StecaGrid DualString inverters are also suitable for outdoor installation.

Integrated DC circuit breaker

To reduce the installation time, the StecaGrid 2010+ inverter has an integrated DC circuit breaker. For safety reasons, the cable cover located above the DC connector can only be removed when the DC circuit breaker is switched off.

StecaGrid 2010+ D Master and StecaGrid 2010+ Master can be combined with StecaGrid 1900 Slave and StecaGrid 2000+ Slave.

Product features

- Two Maximum Power Point Trackers (MPP tracker) per device
- Flexible and expandable
- High efficiency
- DualString concept
- Low weight
- Simple installation
- MasterSlave concept
- Suitable for outdoor installation
- Fanless and maintenance-free
- Integrated data logger
- Wall-mounting with steel wall bracket for very easy installation



StecaGrid 2010+ Master

StecaGrid 2010+ Slave

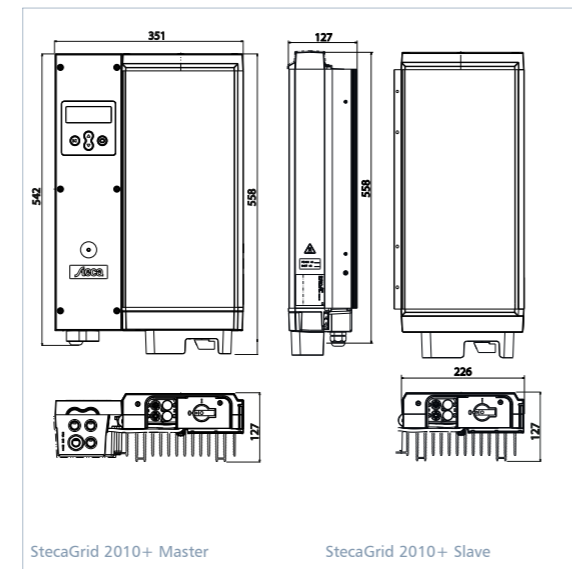

StecaGrid 2010+ Master

StecaGrid 2010+ Slave

Electronic protection functions

- Integrated temperature monitoring with output derating

Displays

- Text LCD display
 - for current output, energy yields, operating parameters, date, time, service information
- Multi-coloured LED shows operating states

Operation

- Multilingual menu navigation
- Four cursor buttons for menu selection

	StecaGrid 2010+ D Master	StecaGrid 2010+ Master	StecaGrid 2010+ Slave
DC input side (PV-generator)			
Maximum start voltage	410 V		
Maximum input voltage	450 V (higher voltages can damage the device)		
Minimum input voltage	80 V		
Minimum input voltage for rated output	132 V		
MPP voltage	80 V ... 400 V		
Maximum input current	2 x 8 A (current limited by inverter) or 1 x 16 A (parallel inputs)		
Maximum input power	1,075 W [per input] or 2,150 W [2 parallel inputs]		
Maximum recommended PV power	2,400 Wp		
Grounding	internal function grounding of the negative input for connecting amorphous and micromorphic thin-film modules		
Derating / limiting	automatic when <ul style="list-style-type: none"> - input power is higher (> 1,075 W / input) - the device is not cooled sufficiently - input currents > 2 x 8 A or 1 x 16 A (parallel inputs) (higher currents are limited by the equipment and therefore will not damage the inverter)		
AC output side (Grid connection)			
Grid voltage	190 V ... 265 V [depending on regional settings]		
Rated grid voltage	230 V		
Maximum output current	10 A		
Maximum output power	2,000 W		
Rated power	2,000 W		
Rated frequency	50 Hz, optional 60 Hz		
Frequency	47.5 Hz ... 52 Hz [depending on regional settings]		
Night-time power loss	1.3 W	1.0 W	0 W
Feeding phases	single-phase		
Power factor	> 0.95		
Distortion factor	< 5 % (max. power)		
Characterisation of the operating performance			
Maximum efficiency	95 %		
European efficiency	93.3 %		93.5 %
MPP efficiency	> 99 %		
Power derating at full power	from 40 °C (T _{amb})		
Switch-on power	20 W		
Standby power	3 W		
Safety			
Isolation principle	HF-transformer with galvanic separation and amplified isolation		
Grid monitoring	MSD, compliant with DIN VDE 0126-1-1	see table of countries	via master
Selectable parameter settings	Netherlands, Belgium, France, Spain, Great Britain, Germany		via master
Operating conditions			
Area of application	indoor rooms with or without air conditioning, outdoors with or without protection		
Ambient temperature	-25 °C ... +60 °C		
Relative humidity	0 % ... 95 %		
Noise emission	< 32 dBA		
Fitting and construction			
Degree of protection	IP 65		
DC input side connection	MultiContact MC 4		
AC output side connection	WAGO 2.5 mm ² ... 6 mm ²		via master
Dimensions (X x Y x Z)	351 x 558 x 140* mm		226 x 558 x 140* mm
Weight	approx. 11 kg		approx. 9 kg
Communication interface	optional StecaGrid Connect with Ethernet interface		
DC circuit breaker	yes, compliant with VDE 0100-712		
Cooling principle	natural convection		
Test certificate	certificate of compliance, CE mark		

*incl. mounting plate

StecaGrid 2010+: Master-Slave combination



StecaGrid 2010+ Master and 2 StecaGrid 2010+ Slaves

[areas of application]



DC circuit breaker for StecaGrid 1900, StecaGrid 2000+

450 V DC, 16 A DC, 2-pole and 4-pole

Steca offers suitable DC circuit breakers especially designed for these DualString inverters. Both a 2-pole and 4-pole circuit breaker are available.

Certificates

- Compliant with DIN VDE 0100-712

► Wiring information for the DC circuit breaker can be found on our website (www.steca.com).



2-pole and 4-pole DC circuit breaker

DC circuit breaker	2-pole	4-pole
DC input side (PV-generator)		
Maximum input voltage	450 V	
Maximum input current	16 A per contact	
Operating conditions		
Area of application	indoor rooms with or without air conditioning, outdoors with or without protection	
Ambient temperature	-20 °C ... +55 °C	
Relative humidity	0 % ... 95 %	
Fitting and construction		
Degree of protection	IP 66	
Terminal (fine / single wire)	10 mm ² / 16 mm ²	
Dimensions (X x Y x Z)	100 x 190 x 93 mm	
Weight	0.6 kg	
Test certificate	CE mark	

PC network interface StecaGrid Connect

and software for system monitoring

Even more convenient, is monitoring with the optionally available StecaGrid Connect network card. Here, the integrated web server makes it possible to display data in a normal web browser (e.g. Internet Explorer) without additional software.

The free StecaGrid Connect User software offers additional possibilities for graphical analysis and archiving of data.

Your own PC is all you need in order to view and analyse all of the solar power system's data at your desk, conveniently presented with the aid of the software, in a graphically understandable format.

With StecaGrid Connect Service, the installer has the ideal tool with which to guarantee prompt, precise, and problem-free service.



StecaGrid Connect User user interface

Remote monitoring

If the inverter is also connected to the Internet, it is possible to monitor the solar energy system from any computer in the world via StecaGrid Connect. Password-protected access occurs with the StecaGrid Connect User/Service software, or simply via a normal web browser.

In addition, Steca offers the option of external system monitoring. Via e-mail, the user is not only informed of their inverters' yields, but also of any faults which arise.

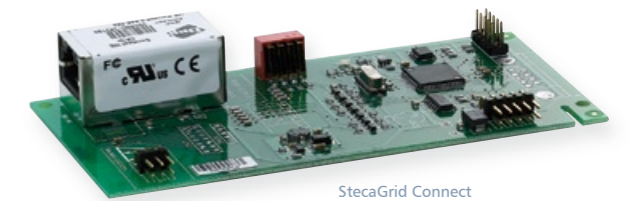

StecaGrid Connect network interface card

	StecaGrid Connect
Fitting and construction	
Dimensions (X x Y x Z)	128 x 62 x 20 mm
Weight	0.05 kg
Communication interface	Ethernet interface
Test certificate	CE mark

Product features

- Integrated web server

Interfaces

- Ethernet interface

Ways of system monitoring:
StecaGrid 1900, StecaGrid 2000+, StecaGrid 2010+

Datalogger and Display

As standard, these DualString inverters provide functions which enable complete integrated monitoring of the solar power system. The system's operating status (voltage, module output, grid frequency and grid voltage) and the energy yields of master and slaves are included. These measured values are shown on the display at all times.



[areas of application]



StecaGrid 9000 3ph

Always symmetrical

The advantage of three-phase feeding is that the produced solar capacity is always symmetrically distributed on all three power conductors to the public power grid. This is the case across the whole output range offered by StecaGrid 9000 3ph. When designing a system, the laborious avoidance of an asymmetry of more than 4.6 kW through the appropriate selection of separate inverters is thus dispensed with. Symmetrical feeding is greatly in the interests of energy supply companies. Lengthy discussions with such companies are therefore a thing of the past.

Long service life

While the voltage passes through zero on the grid-feeding phase, single-phase inverters must temporarily accommodate all energy supplied by the solar modules within the device. This is usually realised by electrolytic capacitors. These components influence the service life of an electronic device, due to the possibility of drying out.

With three-phase inverters, energy is fed into the grid on at least two phases at all times. Thus, the necessity of intermediate storage of energy in the device is greatly reduced, which is of benefit to the system operator with regard to a longer service life (see figure on right hand side).

Flexible connection

Due to the wide input voltage range of 350 V to 800 V, and a maximum input current of 32 A, all commonly available crystalline solar modules can be connected to the StecaGrid 9000 3ph in various configurations. Beyond this, the system is also approved for use with CdTe and CIS / CIGS thin-film modules. Five plug/socket pairs are available for flexible, mechanical DC connection.

Easy handling

Despite its high output, the StecaGrid 9000 3ph is a wall-mounted device. Thanks to the high degree of protection, this inverter can be installed indoors or outdoors. Due to the integrated DC circuit breaker, installation work is made easier, and the installation time is reduced. It is not necessary to open the StecaGrid 9000 3ph during installation.

Product features

- High efficiency
- UniString concept
- Wide input voltage range
- Three-phase, symmetrical grid feeding
- Low DC discharge currents due to special switching concept
- Integrated DC circuit breaker
- Robust metal casing
- Suitable for outdoor installation
- Wall-mounting with steel wall bracket for very easy installation

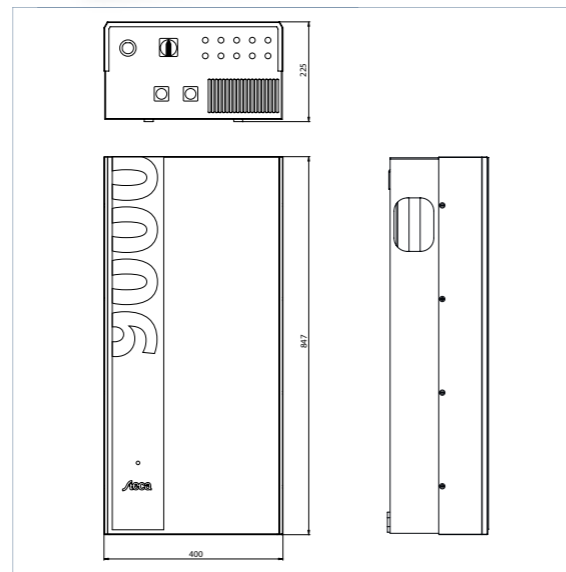

Electronic protection functions

- Integrated temperature monitoring with output derating

Displays

- Multi-coloured LED shows operating states

Options

- System monitoring with WEB'log data loggers

StecaGrid 9000 3ph		Characterisation of the operating performance	
DC input side (PV-generator)		Maximum efficiency	96.2 %
Maximum start voltage	830 V	European efficiency	95.3 %
Maximum input voltage	830 V	MPP efficiency	> 99 %
Minimum input voltage	350 V	Power derating at full power	from 50 °C (T _{amb})
Minimum input voltage for rated output	350 V	Switch-on power	20 W
MPP voltage	350 V ... 680 V	Standby power	9 W
Maximum input current	32 A	Safety	
Maximum input power	10,500 W	Isolation principle	no galvanic isolation, transformerless
Maximum recommended PV power	12,000 Wp	Operating conditions	
Derating / limiting	automatic when - input power is higher - the device is not cooled sufficiently - input currents > 32A (higher currents are limited by the equipment and therefore will not damage the inverter)	Area of application	indoor rooms with or without air conditioning, outdoors with protection
		Ambient temperature	-20 °C ... +60 °C
AC output side (Grid connection)		Relative humidity	0 % ... 95 %
Grid voltage	360 V ... 440 V	Noise emission	< 60 dBA
Rated grid voltage	400 V	Fitting and construction	
Maximum output current	17 A	Degree of protection	IP 54
Maximum output power	9,900 W	DC Input side connection	MultiContact MC4 (5 pairs)
Rated power	9,000 W	AC output side connection	Wieland RST25i5 plug
Rated frequency	50 Hz	Dimensions (X x Y x Z)	400 x 847 x 225 mm
Frequency	47.5 Hz ... 50.2 Hz	Weight	42 kg
Night-time power loss	< 1 W	Communication interface	RS485 to Meteocontrol WEB'log
Feeding phases	three-phase	DC circuit breaker	yes
Distortion factor	< 5 % (max. power)	Cooling principle	temperature-controlled fan
		Test certificate	CE mark, DK 5940

Advantage of three-phase feeding

Power curve P shows the power fed in to the public electricity grid. The grey shaded area shows the energy to be stored in the inverter. The advantage of three-phase feeding is plain to see.

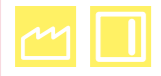
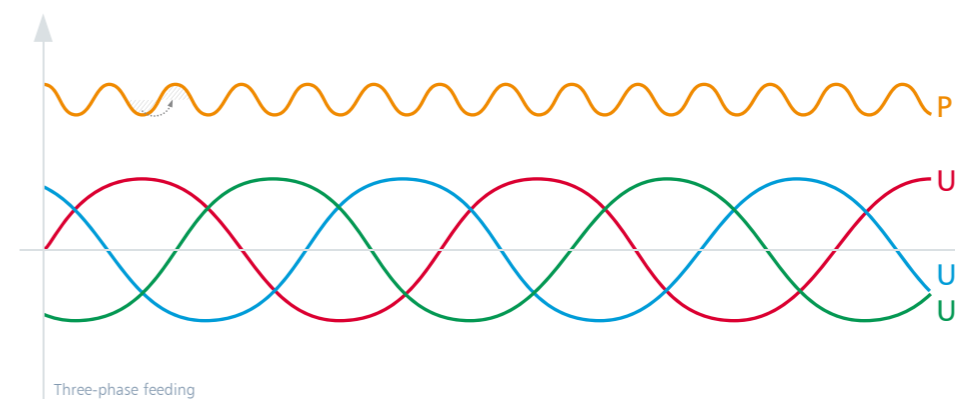
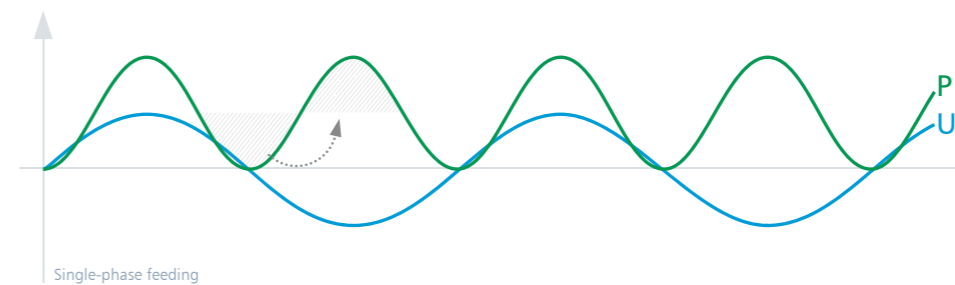

StecaGrid 10 000 3ph

Always symmetrical

The advantage of three-phase feeding is that the produced solar capacity is always symmetrically distributed on all three power conductors to the public power grid. This is the case across the whole output range offered by StecaGrid 10 000 3ph. When designing a system, the laborious avoidance of an asymmetry of more than 4.6 kW through the appropriate selection of separate inverters is thus dispensed with. Symmetrical feeding is greatly in the interests of energy supply companies. Lengthy discussions with such companies are therefore a thing of the past.

Long service life

While the voltage passes through zero on the grid-feeding phase, single-phase inverters must temporarily accommodate all energy supplied by the solar modules within the device. This is usually realised by electrolytic capacitors. These components influence the service life of an electronic device, due to the possibility of drying out.

With three-phase inverters, energy is fed into the grid on at least two phases at all times. Thus, the necessity of intermediate storage of energy in the device is greatly reduced, which is of benefit to the system operator with regard to a longer service life (see figure on right hand side).

Flexible connection

Due to the wide input voltage range of 350 V to 845 V, and a maximum input current of 32 A, all commonly available crystalline solar modules can be connected to the StecaGrid 10 000 3ph in various configurations. Beyond this, the system is also approved for use with CdTe and CIS / CIGS thin-film modules. Five plug/socket pairs are available for flexible, mechanical DC connection.

Easy handling

Despite its high output, the StecaGrid 10 000 3ph is a wall-mounted device. Thanks to the high degree of protection, this inverter can be installed indoors or outdoors. Due to the integrated DC circuit breaker, installation work is made easier, and the installation time is reduced. It is not necessary to open the StecaGrid 10 000 3ph during installation.

Product features

- High efficiency
- UniString concept
- Wide input voltage range
- Three-phase, symmetrical grid feeding
- Low DC discharge currents due to special switching concept
- Integrated DC circuit breaker
- Robust metal casing
- Suitable for outdoor installation
- Wall-mounting with steel wall bracket for very easy installation

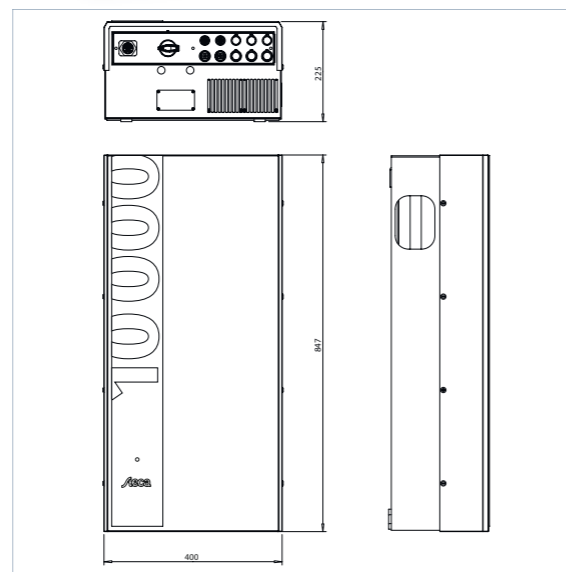

Electronic protection functions

- Integrated temperature monitoring with output derating

Displays

- Multi-coloured LED shows operating states

Options

- Can be connected to the StecaGrid Vision display unit
- System monitoring with WEB'log data loggers

StecaGrid 10 000 3ph		Characterisation of the operating performance	
DC input side (PV-generator)		Characterisation of the operating performance	
Maximum start voltage	845 V	Maximum efficiency	96.3 %
Maximum input voltage	845 V	European efficiency	95.4 %
Minimum input voltage	350 V	MPP efficiency	> 99 %
Minimum input voltage for rated output	350 V	Power derating at full power	from 50 °C (T _{amb})
MPP voltage	350 V ... 700 V	Switch-on power	20 W
Maximum input current	32 A	Standby power	9 W
Maximum input power	10,800 W	Safety	
Maximum recommended PV power	12,500 Wp	Isolation principle	no galvanic isolation, transformerless
Derating / limiting	automatic when - input power is higher - the device is not cooled sufficiently - input currents > 32A (higher currents are limited by the equipment and therefore will not damage the inverter)	Grid monitoring	MSD compliant with DIN VDE 0126-1-1
		Operating conditions	
AC output side (Grid connection)		Area of application	indoor rooms with or without air conditioning, outdoors with protection
Grid voltage	320 V ... 480 V [depending on the regional settings]	Ambient temperature	-20 °C ... +60 °C
Rated grid voltage	400 V	Relative humidity	0 % ... 95 %
Maximum output current	17.7 A	Noise emission	< 60 dBA
Maximum output power	10,300 W	Fitting and construction	
Rated power	9,500 W	Degree of protection	IP 54
Rated frequency	50 Hz	DC Input side connection	MultiContact MC4 (5 pairs)
Frequency	47.5 Hz ... 52 Hz [depending on regional settings]	AC output side connection	Wieland RST25i5 plug
Night-time power loss	< 1 W	Dimensions (X x Y x Z)	400 x 847 x 225 mm
Feeding phases	three-phase	Weight	42 kg
Distortion factor	< 5 % (max. power)	Communication interface	RS485, USB
		DC circuit breaker	yes
		Cooling principle	temperature-controlled fan
		Test certificate	CE mark

Advantage of three-phase feeding

Power curve P shows the power fed in to the public electricity grid. The grey shaded area shows the energy to be stored in the inverter. The advantage of three-phase feeding is plain to see.

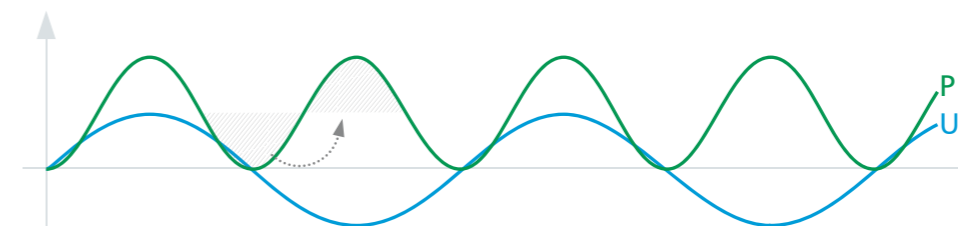

Single-phase feeding

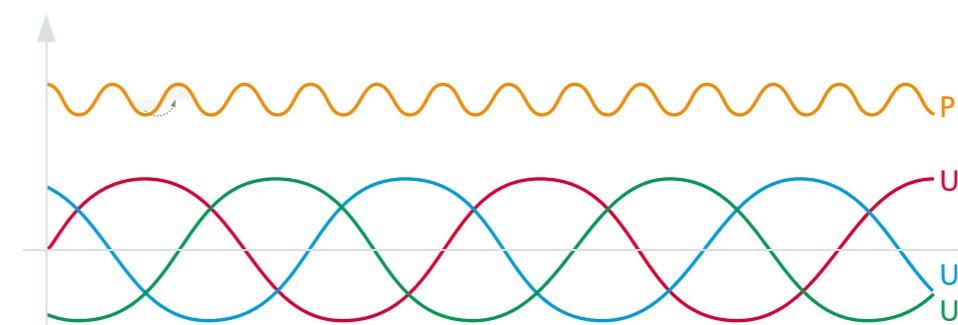

Three-phase feeding

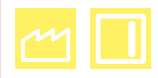

Professional remote monitoring with **meteocontrol WEB'log**

Experience gained from 480 MWp monitored systems

Area of application

- Remote monitoring of photovoltaic systems

Product features

- Solar management
 - Web portal in several languages
 - Convenient evaluation of measurement data
 - High-performance report generator
 - Target/actual comparison of energy yield
 - Online values
- Safer'Sun info
 - Access to your system via your own homepage
 - Administration and allocation of guest access
 - You can integrate evaluations and diagrams in your website
- Safer'Sun portal
 - The Safer'Sun portal can be adapted to your own corporate design
 - Custom-made to your wishes and requirements

Advantages

- Best energy yield
- Innovative and intelligent technology
- Maximum safety
- Guaranteed pay-back!

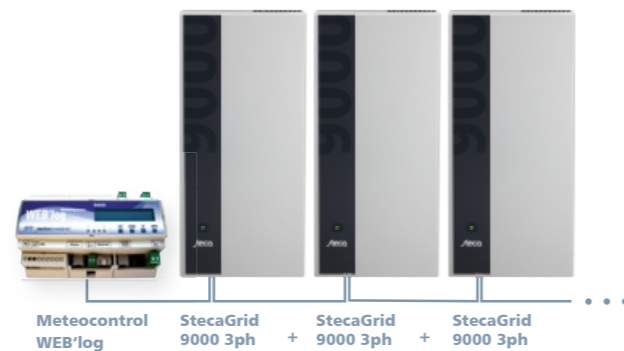

Functional principle of meteocontrol WEB'log

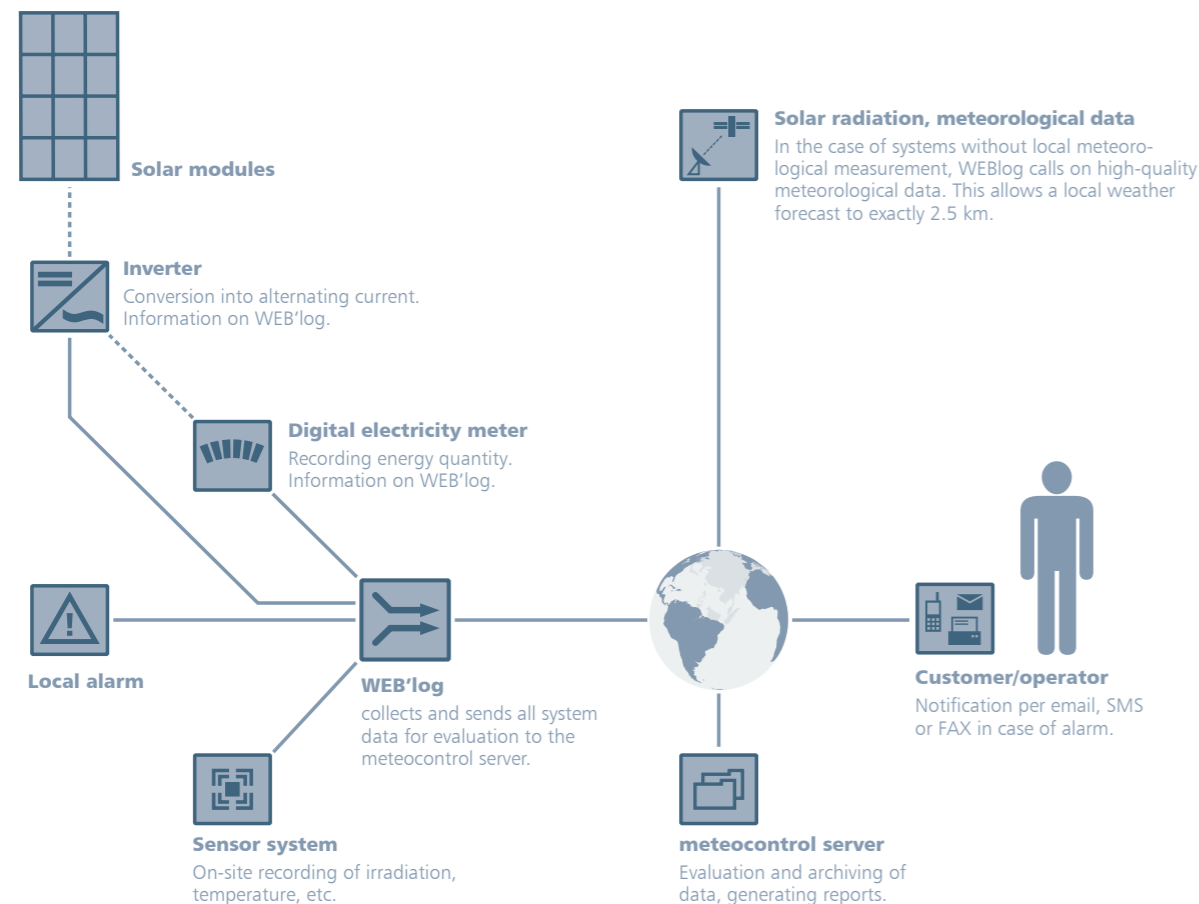

StecaGrid Vision

Display unit

One photovoltaic system – one display

The philosophy behind the StecaGrid Vision display unit is to provide the system operator with a representation of the entire system's data. In the default display, the output and yields of all connected StecaGrid 9000 3ph devices are shown as combined totals. Thus, the operator does not need to go from one inverter to the next, reading out the values individually and adding them up themselves. Naturally, it is also possible to view and compare data from individual inverters.



Up to 20 inverters can be connected

One to 20 StecaGrid 9000 3ph inverters can be connected to the optional StecaGrid Vision display unit. The wired connections between the inverters and to the display unit are realised via Steca's own communication bus.

Easy to operate

The StecaGrid Vision impresses with its design. It is operated by means of four modern capacitive buttons. Graphic curves show the energy yields from the system as a whole, and from individual inverters, thus providing information at a glance, regarding the performance over the course of the day. In addition, StecaGrid Vision has a data logging function, which also enables querying of historical data. Error messages regarding the system as a whole, as well as individual inverters, are shown in plain text.

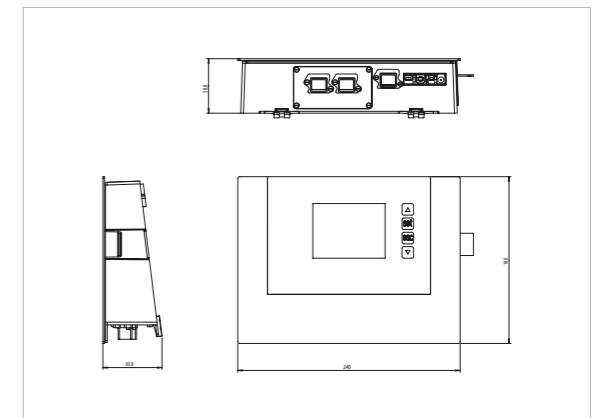

Product features

- Integrated data logger

Display

- Multifunction graphic LCD display with backlighting
 - for current output, energy yields, operating parameters, date, time, service information
- Animated representation of yield

Operation

- Multilingual menu navigation

StecaGrid Vision	
Application conditions	
Area of application	indoor rooms, with or without air conditioning
Interface to StecaGrid 10 000 3ph	Steca bus with max. 1,000 m cable length
Ambient temperature	-20 °C ... +45 °C
Humidity	0 % ... 95 %
Noise emissions in standard operating conditions	silent
Equipment and design	
Protection class	IP 20
Dimensions (X x Y x Z)	240 x 180 x 63,8 mm
Weight	450 g
Power supply	230 V mains adapter plug (included in delivery)
Communication interface	USB, optional ethernet
Range	1,000 m
Test certificate	CE mark

Interconnection

StecaGrid 10 000 3ph UniString inverters and StecaGrid Vision display unit:





Professional system dimensioning

... with StecaGrid Configurator 3.0

The update version of the StecaGrid Configurator makes it possible to plan a photovoltaic system in an even more professional manner. It offers a wealth of improvements compared to its forerunner, the 2.3 version.

This version is self-contained and functions independently of Microsoft Excel, offering a convenient user interface. There are four different options for determining the size of a photovoltaic system after selecting a module type. In addition, modules stored in a large database can be filtered according to specific criteria. This is followed by the selection of MiniString, DualString and UniString inverters according to a range of specifications, for example the installation site and rated AC or DC power. The calculated cost of generating electricity is taken as the standard selection criterion. To help with the specifications, the programme includes different values for the cost of systems planning as well as for modules, wiring, installation systems, etc. The installing company can provide their client data and company logo, which will appear on the printouts. A total of 30 locations throughout Germany offer irradiation data to help predict annual energy yield.

The predicted annual energy yield and the similarly editable values for the discount factor and operating time together allow the exact calculation in cents per kilowatt hour of the costs incurred by a system in producing electricity. On the basis of the electricity generation costs, it is possible to ascertain at a glance whether it would be more efficient to use the inverter with one more solar module, or one fewer. A list of required parts, the connection diagram and a summary of the project data all guarantee professional preparation for sales meetings with customers.

The software is available free of charge at www.steca.com.

Service

Service-Information

for StecaGrid inverters

Naturally we will provide you with our expert advice and support after your purchase, during installation, and during the long years of operation of your PV system.

Replacement service

The modular design of the StecaGrid system, along with our rapid replacement service, ensure that your solar power system feeds the grid with maximum yields. In case of a StecaGrid inverter malfunctioning, it will be exchanged with a corresponding replacement device as quickly as possible by Steca or a Steca service partner („advance replacement“). In this way, any loss of grid-feed remuneration is kept to a minimum if servicing is required.

Manufacturer's guarantee

Our StecaGrid products come with a 5-year commercial guarantee as standard. Furthermore, we offer the system operator the chance to take out an extended guarantee of 10 years. You will find the extended guarantee with each product.

Replacement devices after the guarantee period

Even after the guarantee period is over, with our replacement devices at low inclusive prices, we help to ensure the continued economic efficiency of your solar power system

Monitoring

If your solar power system is equipped with the relevant communication devices, it is possible to monitor your system remotely. Just ask for further information.

Training

According to your requirements, and upon consultation, we can offer you training on our StecaGrid products, system configuration, or data communication

The dates of upcoming training sessions for installers can be found on our website.

Contact

In addition to the contact details you have, our hotline is available to you:

- Fon: +49 (0) 700 StecaGrid
+49 (0) 700 783224743
- Fax: +49 (0) 8331 8558-132
- E-Mail: service@stecasolar.com

Here you can get support without delay.



"From the assembly of the components to the finished device – from the development to the after-sales service."

Environmental protection in series

We are thinking of tomorrow

For Steca, there are many aspects to environmental and climate protection and the resultant reduction in CO₂ and environmental poisons.

With Steca charging technology, the devices in battery charging systems use the maximum energy storage potential and treat damaged or totally discharged batteries. Complete management systems for bus maintenance facilities help prevent environmental pollution by reducing cold-run phases.

In addition to the obvious need to apply environmentally-friendly processes, electronic products from Steca contribute both to reducing energy consumption and environmental pollution around the world, as well as to spreading the use of regenerative energy sources by means of solar technology.

Not without reason is Steca listed as an authority for energy generation in the German federal government's environmental technology atlas "Green Tech made in Germany". Products in the area of solar electronics facilitate environmentally-friendly use of clean and free solar energy. Today, in the photovoltaic and solar thermal energy sectors, over 1.5 million controllers manage and control solar energy systems around the world.

The company contributes to energy savings with the millions of electronic components it produces for devices classified in energy efficiency class A⁺⁺, such as motion detectors or network circuit breakers. Devices for water and weather measuring technology facilitate further research into our environment. Electronics utilised in the fields of medicine and industry regulate analysis and production processes and thereby save energy and materials. Further examples include photovoltaic controllers for improving the energy balance in automobile applications. All battery-operated devices are developed for minimum electricity consumption with maximum output.

Steca environmental policy is based on sustainability and environmental compatibility, with a view to providing services and producing products for an ecological future. The company takes account of the whole value-added chain and involves suppliers and customers. Steca is certified in accordance with ISO 14001:2004 and organised in accordance with the EU Environmental Management and Audit Scheme.



Solar Home Systems

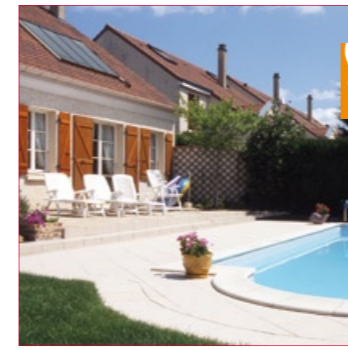

Solar controllers



Inverter Systems

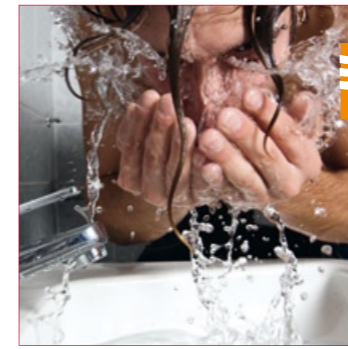

Heating and domestic hot water controllers



Hybrid Systems



System controllers

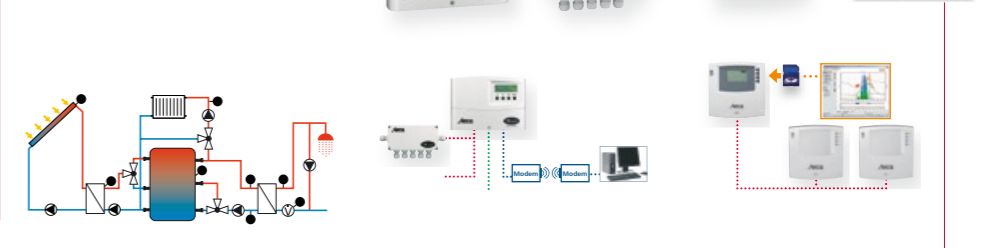



Mobile Use



Stationary Use



Equipment





PV Grid Connected



Residential systems
single-family houses, apartment buildings, carports and garages



Commercial systems
for agriculture and industry and ground-mounted installation



Specialist in "difficult roofs"
Systems for shading and differently aligned roof surfaces



MiniString inverter
inverter for small strings with one MPP tracker per device



DualString inverter
inverter with two MPP trackers per device



UniString inverter
inverter with one MPP tracker per device



Inverter
with low power



Inverter
with average power



Inverter
with high power



Software
for system dimensioning



Information

Symbols

Exclusion of liability

Steca Elektronik GmbH reserves the right to supplement and change the product range offered in the catalogue, or to remove products from the range. Please contact Steca if you require additional or more up-to-date product information. The information in this catalogue is not exhaustive. We compiled this information with care. In spite of this, it may not have been updated or may no longer be applicable in individual cases. We accept no liability for imprecise or missing information in this catalogue.

Copyright Steca Elektronik GmbH ("Steca"). Steca is a protected trademark of Steca Elektronik GmbH. This trademark may only be used by third parties with our express prior permission. The sole owner of the rights to the images and logos and texts is Steca. Steca allows the free use of product pictures and graphics in the context of the presentation of its own products, as long as neither product pictures nor graphics are altered or edited, in particular with regard to cropping, modification, distortion or other deformations. The permission of Steca must always be gained for any other commercial use. "Steca Elektronik GmbH" must always be indicated as the source of the images. In return for the provision of the pictures free of charge, Steca requests a sample copy when they are used in print media, and a brief notification when they are used in film and electronic media. You agree that this agreement does not require a signature in order to become valid. The pertinent laws of the Federal Republic of Germany apply for the use of this catalogue by third parties and the use of the corresponding terms and conditions.

Images from Steca, www.burger-fotodesign.de, www.photocase.com and www.marx-studios.de and www.fotolia.com.



steca
www.steca.com

steca
www.steca.com



„PV Grid Connected – Power from the sun for everyday use.“



Steca Elektronik GmbH
Mammostraße 1
87700 Memmingen
Germany
Fon +49 (0) 8331 8558-0
Fax +49 (0) 8331 8558-132

732.677 | 14.2010
© by Steca

PV Grid Connected